

OREx2 G2

Zone 2, 22

High bay lighting specific for explosive environments

II 3G Ex ec op is IIC T5..T4 Gc
 II 3D Ex tc op is IIIC T80°C ..T115°C Dc

ATEX certificate No: OBAC 21 ATEX0135X
 IECEx certificate No: IECEx OBAC 21.0003X

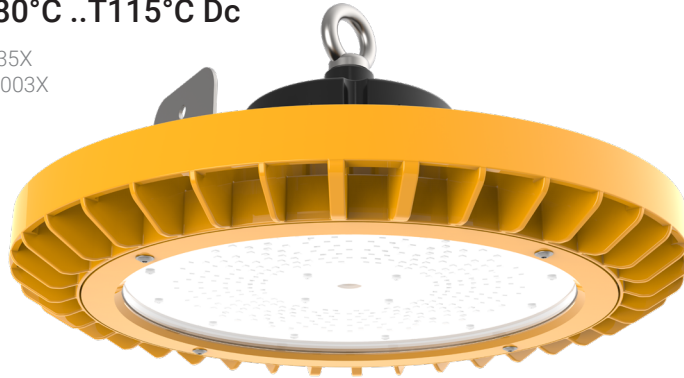

Benefits

- High bay ready for hazardous environments with up to **41,850 lm**.
- Extreme resistance to weather and tough industrial conditions thanks to its glass cover and **copper-free** aluminium housing.
- Wide temperature range, from **-32°C up to 75°C**.
- Suitable for **outdoor**
- Several accessories to improve the installation.

Characteristics



Mechanical characteristics

Housing	Copper-free casing aluminium alloy with surface protected against impacts and corrosive environments Yellow RAL 1003 Grey RAL 7035 optional
Diffuser	Hardened glass
Eyebolt	Stainless steel

Electrical characteristics

Connection	ICB version: 3- pole screwless connector 3 - wire cable coming from the lamp
Power factor	> 0.97 full load
THD	< 15% full load
Inrush current	75A full load
Class protection	Class I
Rated voltage	90-305VAC / 140-250VDC

Functional characteristics

Lifetime	L80 90,000 at 25°C
----------	--------------------



RoHS REACH

Photometrical characteristics

SDCM	< 3
------	-----

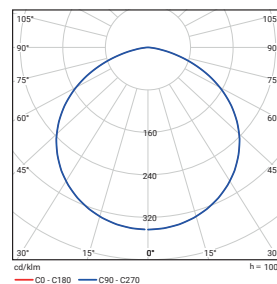



OREx2 G2

Description

FAMILY	DIAMETER (mm)	LUMINOUS FLUX (lm)	CRI	LIGHT COLOUR (K)	DRIVER	EXTERNAL CONNECTION	TEMPERATURE RANGE
> OREx2	> 38: Ø380	> 62: 6200 > 93: 9300 > 124: 12400 > 155: 15500 > 186: 18600 > 217: 21700 > 232: 23200 > 248: 24800 > 279: 27900 > 310: 31000 > 341: 34100 > 372: 37200 > 403: 40300 > 418: 41850	> 8: >80	> 40: 4000K	> -: non dimmable	> 0.25M: with 0.25M external cable > CG ICB: polyamide cable gland, with OREx1 housing	> HT: high temperature version up to 75°C with an additional heat sink

Special options under request

Ask our Sales Team for more details
¹ Only available for IPS versions

> 30: 3000K
 > 50: 5000K
 > 65: 6500K

> ETDD: DALI dimmable¹

> IPS: with external power supply equipped with integrated connected cable

Operational data

Description	Order number	Luminous flux (lm)	Power (W)	Efficiency (lm/W)	Colour temperature (K)	CRI	Temperature range
OREx2 G2 38 62-840 0.25M	10348760	6200	40	155	4000	80	-32°C - +60°C
OREx2 G2 38 93-840 0.25M	10348761	9300	60	155	4000	80	-32°C - +60°C
OREx2 G2 38 124-840 0.25M	10348762	12400	80	155	4000	80	-32°C - +60°C
OREx2 G2 38 155-840 0.25M	10348763	15500	100	155	4000	80	-32°C - +60°C
OREx2 G2 38 186-840 0.25M	10348764	18600	120	155	4000	80	-32°C - +60°C
OREx2 G2 38 217-840 0.25M	10348765	21700	140	155	4000	80	-32°C - +55°C
OREx2 G2 38 232-840 0.25M	10348766	23250	150	155	4000	80	-32°C - +55°C
OREx2 G2 38 248-840 0.25M	10348767	24800	160	155	4000	80	-32°C - +55°C
OREx2 G2 38 279-840 0.25M	10348768	27900	180	155	4000	80	-32°C - +55°C
OREx2 G2 38 310-840 0.25M	10348769	31000	200	155	4000	80	-32°C - +55°C
OREx2 G2 38 341-840 0.25M	10348770	34100	220	155	4000	80	-32°C - +55°C
OREx2 G2 38 372-840 0.25M	10348771	37200	240	155	4000	80	-32°C - +55°C
OREx2 G2 38 403-840 0.25M	10348772	40300	260	155	4000	80	-32°C - +50°C
OREx2 G2 38 418-840 0.25M	10348773	41850	270	155	4000	80	-32°C - +50°C
WITH CABLE GLAND (ICB)							
OREx2 G2 38 155-840 CG ICB	10348774	15500	100	155	4000	80	-32°C - +60°C
OREx2 G2 38 186-840 CG ICB	10348775	18600	120	155	4000	80	-32°C - +60°C
OREx2 G2 38 248-840 CG ICB	10348776	24800	160	155	4000	80	-32°C - +55°C
OREx2 G2 38 310-840 CG ICB	10348777	31000	200	155	4000	80	-32°C - +55°C
OREx2 G2 38 403-840 CG ICB	10348778	40300	260	155	4000	80	-32°C - +50°C
HIGH TEMPERATURE (HT)							
OREx2 G2 38 62-840 0.25M HT	10348757	6200	40	155	4000	80	-32°C - +75°C
OREx2 G2 38 93-840 0.25M HT	10348758	9300	60	155	4000	80	-32°C - +75°C
OREx2 G2 38 124-840 0.25M HT	10348759	12400	80	155	4000	80	-32°C - +75°C



OREx2 G2

Dimensions and logistics

Description	Ø	Y						
	mm	mm	L x W x H mm	Item	Pcs/ Box	Box	Groupage Pcs/Euro pallet	FTL / container Pcs/Double pallet
OREx2 G2 ...	380	150	390 x 390 x 200	6.8	1	7.8	48	48
OREx2 G2... ICB	380	125	390 x 390 x 200	7.2	1	8.2	48	48
OREx2 G2...HT	380	390	440 x 440 x 410	8.3	1	9.3	48	48

Please check with our Back Office to confirm logistic data

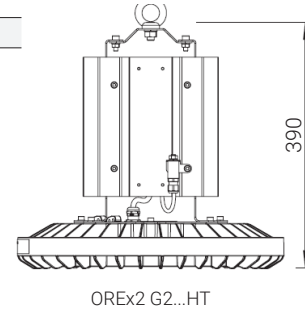
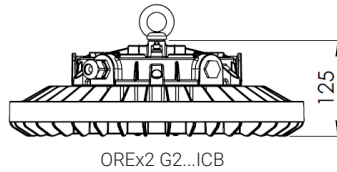
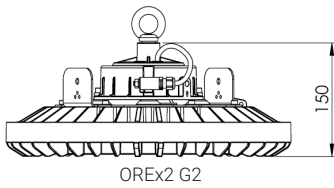

Accessories

10348752	Bracket for tube mounting for OREx G2
10348753	Bracket for surface mounting for OREx G2
10230425	ATEX junction box 80x75x75mm
10225340	ATEX junction box 122x120x90mm
10376674	Nickel brass Ex cable gland, M25, with nut and ring, 1 unit
10376675	Nickel brass Ex cable gland, M20, with nut and ring, 1 unit

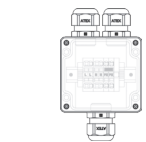
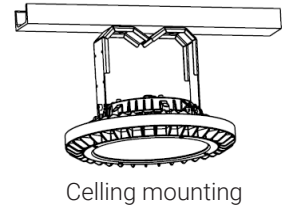
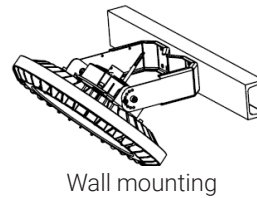

10225340 / 10230425



10376674 / 10376675

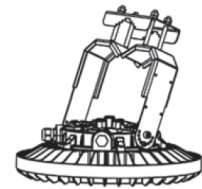

Tube mounting