

Protected luminaires



Catalogue





The partner you can trust

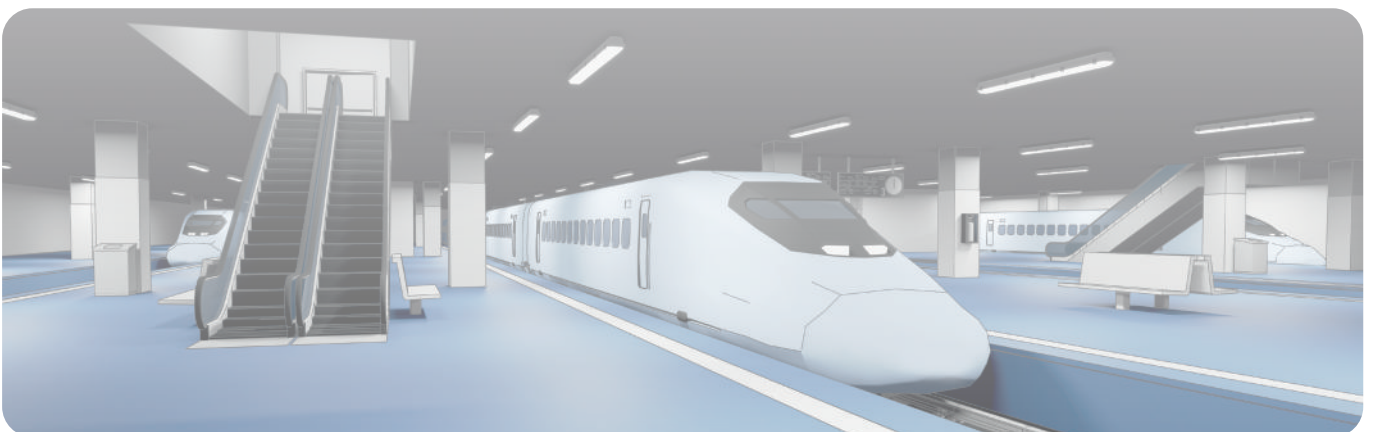

Index

4 ZALUX

8 Protected luminaires

8 NEZA

COMING SOON

10 NEZA HE

10 NEZA STP

14 NEZA BIO

16 ROCKA

NEW

20 KE

26 ZALUX BASE

28 ZALUX BASE HE PMMA

28 ZALUX BASE STP

32 ZALUX BASE D.O.

34 IBERA

38 DUNA FLEX



40 DUNA FLEX HE HIGH BAY

40 DUNA FLEX HE+

44 DUNA FLEX STP

44 DUNA FLEX ST

48 DUNA BIO

50 EURLEDA G3



54 Luminaires for specific applications

54 STRONGERTUBE



56 STRONGERTUBE G2

56 STRONGERTUBE G2 ZB

60 ZALEDA



64 Luminaires designed for LED tube

64 ALHAMA



66 ALHAMA LED-T8

68 ALHAMA T-LED

70 PE



72 PEM T-LED

72 PEP T-LED

76 Connected lighting for industrial areas

78 Case studies

78 Illuminating a smart car park with KE



82 Illuminating a warehouse with NEZA



86 Technical information

86 Specifications / Luminaires with emergency kit

87 Icons / Applications

88 Resistance to chemical agents

89 Ingress and impacts protection

90 General sale conditions

1980 Foundation

3.5M Luminaires manufactured per year

360 Employees

75 Countries with market presence



zalux





We are the European leader for luminaires with high protection ratings

Specialised in the development and manufacturing of reliable and durable luminaires for extreme conditions such as tough temperatures, dust, humidity and chemicals

- Protected luminaires

Efficient and quality luminaires specific for industrial applications, with a wide range of options.

- Ex luminaires

Explosion proof LED luminaires certified for use in EX-Zones according to ATEX and IECEx standards.

- Farming luminaires

Customer-oriented lighting solutions for the agricultural and horticultural market.

- Components

Luminaire parts and accessories for your protected luminaires.

- OEM services

OEM development and manufacturing of customised lighting products for your specific needs.



- Headquarters in Zaragoza, Spain
- 3 manufacturing plants in Alhama de Aragón
- Quality Made in Spain

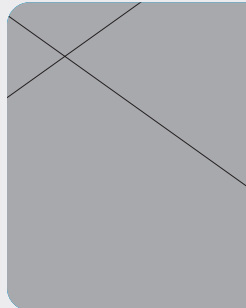

Alhama I

- Plastic injection
- Compression press
- Extrusion



Alhama II

- Metal workshop
- ATEX workshop
- Automated wiring robots
- 20 assembly lines for LED
- Electronic components assembling



Alhama III

- New assembling area
- 1500m² premises
- 13 production lines



Laboratory

- Thermal and endurance tests
- IPX5 – X6 humidity tests
- Impact tests
- Product safety tests



Warehouse

- 10,000m² storage
- For 5,800 Europallets
- With advanced computer systems

Our commitment to sustainability

We contribute to the Sustainable Development Goals by focusing our sustainability strategy on the following areas:

Research new environmentally friendly materials for our luminaires and reduce packaging.









Incorporate smart technologies in our solutions, to contribute to the efficiency of installations.

Design efficient production processes, with photovoltaic self-consumption systems in our plants to reduce our environmental impact.



Connectivity, flexibility and sustainability in the new ZALUX luminaire

Usual applications:

NEZA HE	 Aviation	 High bay	 Smart parking
NEZA STP	 Warehouse	 Parking	 Factory
NEZA BIO	 Logistics	 Warehouse	 Parking

LUMINA



NEW

COMING SOON



VAIRE NEZA



NEZA HE

COMING SOON

New appealing **original** design

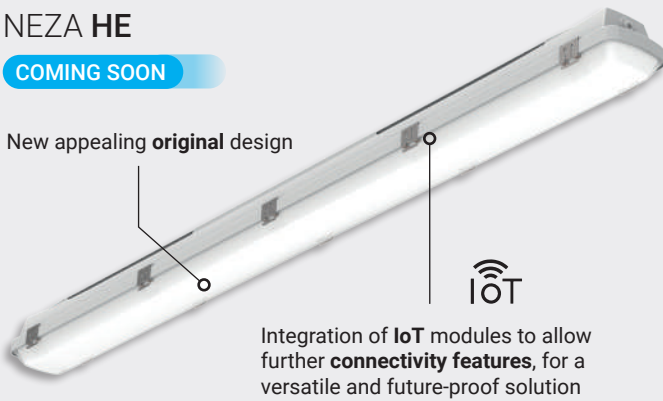

Integration of **IoT** modules to allow further **connectivity features**, for a versatile and future-proof solution

5 YEARS warranty



NEZA STP

COMING SOON

Eco-designed and produced with renewable energy

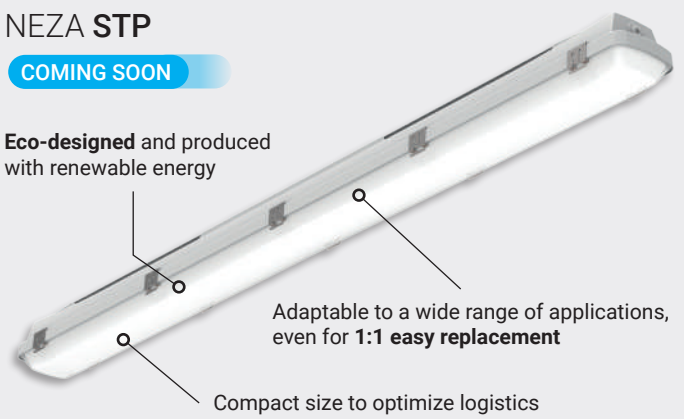

Adaptable to a wide range of applications, even for **1:1 easy replacement**

Compact size to optimize logistics

5 YEARS warranty



Characteristics

		NEZA HE		NEZA STP	
Mechanical		IP66	IK03	IP66	IK08
Housing		Injected polycarbonate Grey RAL 7035			
Diffuser		Injected PMMA with UV protection		Injected polycarbonate with UV protection	
Closing Clips		Stainless steel			
Gasket		PWIS-free silicone Replaceable gasket, optional			
Gear tray		Galvanized sheet			
Cable entry		Cable gland		Grommet	
Fixing clips		Stainless steel			
Suspension triangles		Stainless steel			
Functional					
Lifetime		L80 100,000 hours		L80 50,000 hours	
Fire protection	Flammability (UL94):	HB		V2	
	Glow wire test (EN 60595-2-11):	650°C		850°C	
Electrical					
		Frequency 0-50/60Hz Rated Voltage 220-240V NON-SELV			
Connection		3/5 pole push wire terminal block			
Power factor		>0.95 full load			
THD		<10% full load			
Flicker factor		<1%			
Photometrical					
Luminous flux		Up to 15,000lm		Up to 6,000lm	
Efficiency		Up to 170lm/W		Up to 140lm/W	
SDCM		< 3			
Polar diagram					

Estimated data as of printing date

Applications

NEZA HE



Aviation



High bay



Smart parking



Factory



Logistics



High bay locations with demanding lighting needs require superior luminaires. NEZA, with up to **15,000lm** and **different optics** offers a lumen package to illuminate, for example, huge hangars which reach up to **50°C ambient temperature**.

With up to 170lm/W and a long lifetime of 100,000 hours, it also cares for the efficiency of the installation.



Thanks to NEZA **specific IoT modules**, with sensors or cameras, you can benefit from further functionalities such as **security**, by integrating surveillance cameras, or **efficiency**, with daylight or presence sensors.

This way, installation can be made **quicker** in less steps, while the appearance of the space remains clean.

NEZA STP



Warehouse



Parking



Factory



Automotive



Corridor



In long warehouse corridors, installation of NEZA with **through wiring** helps to optimize the electrical project.

Furthermore, its small size optimizes the transportation of the material, which, together with its manufacturing with renewable energy sources, helps **care for the environment**.



NEZA enables **1:1 replacement** of traditional luminaires in a wide variety of applications, facilitating maintenance operations.

It includes, as an option, an emergency kit with 1 hour of autonomy (3 hours optional), to cover **additional needs with the same luminaire**.

Estimated data as of printing date

NEZA HE

LENGHT (mm)	OPTICS	LUMINOUS FLUX (lm)	CRI	LIGHT COLOUR (K)	DRIVER	DIFFUSER	EMERGENCY KIT	CONNECTION	THROUGH WIRING	TEMPERATURE RANGE
6: 600 12: 1200 15: 1500	L: lambertian W VW XW N AW	20: 2000 25: 2500 40: 4000 50: 5000 60: 6000 80: 8000 100: 100000 150: 150000	8: >80	40: 4000 65: 6500 30: 3000 27-65: 2700-6500 tunable white	ET: non-dimmable ETDD: DALI dimmable	PM: PMMA	EB1: 1 hour EB3: 3 hours	CG: cable gland	5x2.5mm ² Other under request	HT: high temperature version -30°C +50°C

More options available:

- Casambi control module
- Central battery system connection
- High frequency sensor (HFS)
- Fast connector

NEZA STP

LENGHT (mm)	OPTICS	LUMINOUS FLUX	CRI	LIGHT COLOUR (K)	DRIVER	DIFFUSER	EMERGENCY KIT	THROUGH WIRING
6: 600 12: 1200 15: 1500	L: lambertian W VW XW N AW	20: 2000 40: 4000 60: 6000	8: >80	40: 4000 30: 3000 65: 6500 27-65: 2700-6500 tunable white	ET: non-dimmable ETDD: DALI dimmable	PC: polycarbonate	EB1: 1 hour EB3: 3 hours	3x1.5mm ² Other under request

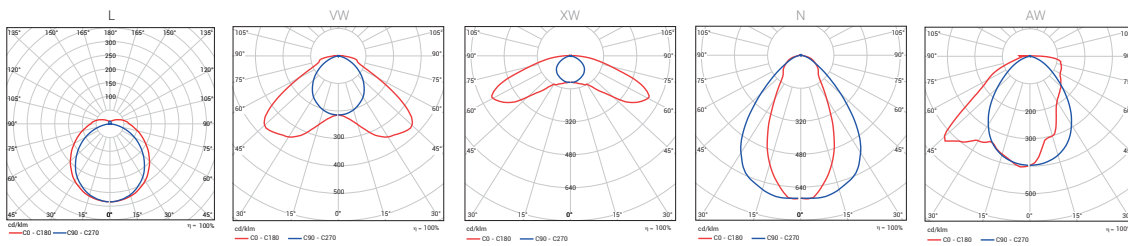

NEZA installation is easier.

Thanks to its crimped gear tray and the attached hose, installers can benefit from a **quicker and smoother mounting**. Also, it has suitable stainless steel clips and a flexible mains entry.



Accessories

Description	Reference	Description	Reference
 Suspension wire 2m hook and fastener, 1 unit ²	10103049	 ZBWM wall mounting accessory (allows luminaire rotation), 2 pieces set	10207593
 Theft protection (required for wall mounting), set for 1 luminaire	10149442	 Fixing clips in stainless steel 316L, 2 units	10256809

² 2 units required per luminaire

Estimated data as of printing date

Operational data

NEZA HE

Description	Reference	Luminous flux (lm)	Emergency flux (lm)	Power (W)	Efficiency (lm/W)	Temperature range
NHE 6 L 20-840 ET PM CG	10347335	2000	-	12	165	-30°C +40°C
NHE 6 L 20-865 ET PM CG	10347412	2000	-	12	165	-30°C +40°C
NHE 6 L 20-840 ETDD PM CG	10347336	2000	-	12	165	-30°C +40°C
NHE 6 L 20-840 ET PM CG 5X2.5	10347337	2000	-	12	165	-30°C +40°C
NHE 12 L 40-840 ET PM CG	10347339	4000	-	23,5	170	-30°C +40°C
NHE 12 L 40-865 ET PM CG	10347413	4000	-	23,5	170	-30°C +40°C
NHE 12 L 40-840 ETDD PM CG	10347340	4000	-	23,5	170	-30°C +40°C
NHE 12 L 40-840 ET PM CG 5X2.5	10347341	4000	-	23,5	170	-30°C +40°C
NHE 15 L 60-840 ET PM CG	10347342	6000	-	35	170	-30°C +40°C
NHE 15 L 60-865 ET PM CG	10347415	6000	-	35	170	-30°C +40°C
NHE 15 L 60-840 ETDD PM CG	10347343	6000	-	35	170	-30°C +40°C
NHE 15 L 60-840 ET PM CG 5X2.5	10347344	6000	-	35	170	-30°C +40°C
HIGH LUMEN						
NHE 6 L 25-840 ET PM CG	10347355	2500	-	15	165	-30°C +40°C
NHE 12 L 50-840 ET PM CG	10347357	5000	-	29,5	170	-30°C +40°C
NHE 15 L 80-840 ET PM CG	10347362	8000	-	47	170	-30°C +40°C
NHE 15 L 80-840 ET PM CG 5X2,5	10347363	8000	-	47	170	-30°C +35°C
NHE 15 L 80-840 ETDD PM CG 5X2,5	10347364	8000	-	47	170	-30°C +35°C
NHE 15 L 100-840 ET PM CG	10347367	10000	-	59	170	-30°C +40°C
NHE 15 L 100-840 ET PM CG 5X2,5	10347368	10000	-	59	170	-30°C +35°C
NHE 15 L 150-840 ET PM CG	10347369	15000	-	88	170	-30°C +25°C
NHE 15 L 150-840 ET PM CG 5X2,5	10347370	15000	-	88	170	-30°C +20°C
HIGH TEMPERATURE						
NHE 12 L 40-840 ET PM CG HT	10347397	4000	-	23,5	170	-30°C +50°C
NHE 15 L 60-840 ET PM CG HT	10347402	6000	-	35	170	-30°C +50°C
EMERGENCY KIT						
NHE 6 L 20-840 ET PM EB1 CG	10347418	2000	700	12	165	0°C +40°C
NHE 12 L 40-840 ET PM EB1 CG	10347426	4000	700	23,5	170	0°C +40°C
NHE 15 L 60-840 ET PM EB1 CG	10347432	6000	700	35	170	0°C +40°C
NHE 15 L 80-840 ET PM EB1 CG	10347365	8000	700	47	170	0°C +40°C
NHE 15 L 80-840 ET PM EB1 CG 5X2,5	10347366	8000	700	47	170	0°C +35°C

NEZA STP

Description	Reference	Luminous flux (lm)	Emergency flux (lm)	Power (W)	Efficiency (lm/W)	Temperature range
NSTP 6 L 20-840 ET PC	10347485	2000	-	14,5	138	-20°C +35°C
NSTP 6 L 20-840 ETDD PC	10347486	2000	-	14,5	138	-20°C +35°C
NSTP 6 L 20-840 ET PC 3X1.5	10347487	2000	-	14,5	138	-20°C +35°C
NSTP 12 L 40-840 ET PC	10347488	4000	-	28,5	140	-20°C +35°C
NSTP 12 L 40-840 ETDD PC	10347489	4000	-	28,5	140	-20°C +35°C
NSTP 12 L 40-840 ET PC 3X1.5	10347490	4000	-	28,5	140	-20°C +35°C
NSTP 15 L 60-840 ET PC	10347491	6000	-	43	140	-20°C +35°C
NSTP 15 L 60-840 ETDD PC	10347492	6000	-	43	140	-20°C +35°C
NSTP 15 L 60-840 ET PC 3X1.5	10347493	6000	-	43	140	-20°C +35°C
EMERGENCY KIT						
NSTP 6 L 20-840 ET PC EB1	10347494	2000	-	14,5	140	0°C +35°C
NSTP 12 L 40-840 ET PC EB1	10347495	4000	700	28,5	140	0°C +35°C
NSTP 15 L 60-840 ET PC EB1	10347496	6000	700	43	140	0°C +35°C

Dimensions and logistics

Description	X (mm)	Xm (mm)	Y (mm)	Z (mm)	L x W x H (mm)	KG Item	Pcs./Box	KG Box ¹	Groupage Pcs./pallet	FTL/container Pcs./Double pallet
N... 6...	703	172 - 436	101	84	735 x 110 x 95	1.3	1	1.2	238	154 + 154
N... 12...	1265	396 - 1000	101	84	1300 x 110 x 95	1.8	1	2.1	119	77 + 77
N... 15...	1565	695 - 1300	101	84	1600 x 110 x 95	2.3	1	2.7	119	77 + 77

¹ Weight in ETDD versions: +0.2KG

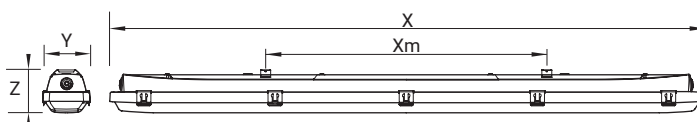

Estimated data as of printing date

NEZA BIO

COMING SOON

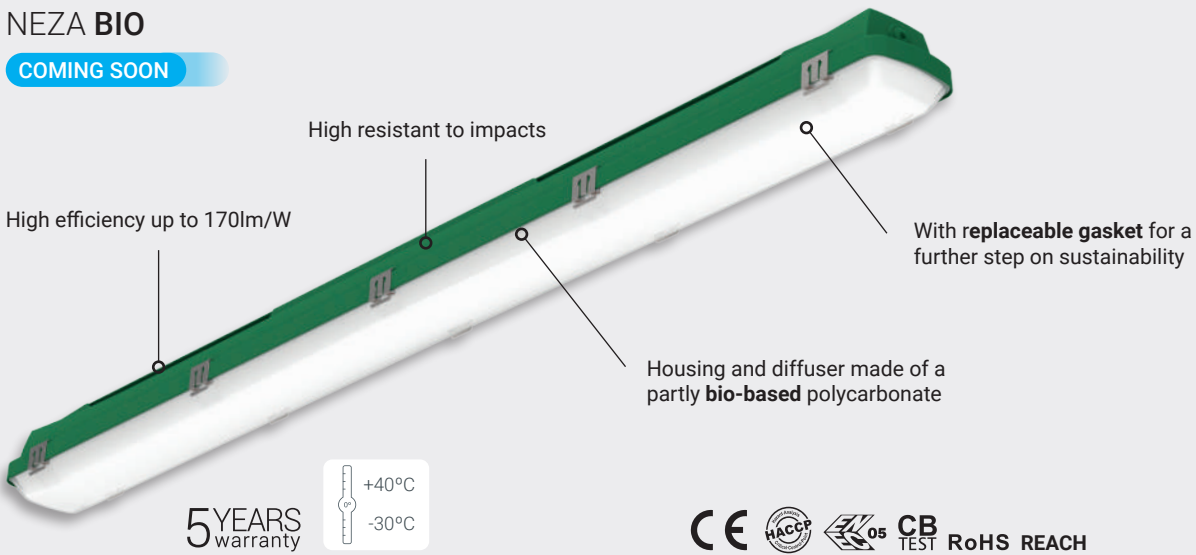

Characteristics

NEZA BIO

Mechanical

IP66 IK08

Housing	Injected partly bio-based polycarbonate (not derived from petroleum derivatives) Green RAL 6017 (available in grey RAL 7035 under request)
Diffuser	Injected partly bio-based polycarbonate
Closing Clips	Stainless steel
Gasket	Replaceable gasket
Gear tray	Galvanized sheet
Cable entry	Cable gland
Fixing clips	Stainless steel
Suspension triangles	Stainless steel

Functional

Lifetime	L80 100,000 hours
Fire protection	Flammability (UL94): HB
	Glow wire test (EN 60595-2-11): 850°C

Electrical



Connection	3/5 pole push wire terminal block
Power factor	>0.95 full load
THD	<10% full load
Flicker factor	<1%

Photometrical

Luminous flux	Up to 6,000lm
Efficiency	Up to 170lm/W
SDCM	< 3



Estimated data as of printing date

Applications

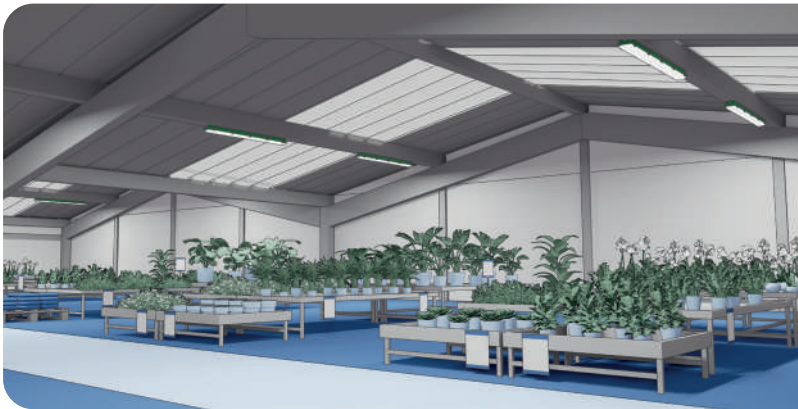

For a wide range of applications, NEZA BIO offers **superior lighting quality** with very high efficiency up to 170lm/W to get the most of the energy use.

It **cares for sustainability and circular economy**, thanks to the use of recyclable bio-based materials with biomass origin and the incorporation of replaceable components, such as its gasket.

Options Special options in grey under request.

LENGTH (mm)	OPTICS	LUMINOUS FLUX	CRI	LIGHT COLOUR (K)	DRIVER	DIFFUSER	SENSOR	CONNECTION
6: 600 12: 1200 15: 1500	L: lambertian W VW XW N AW	20: 2000 40: 4000 60: 6000	8: >80	40: 4000 30: 3000 27-65: 2700-6500 tunable white	ET: non-dimmable ETDD: DALI dimmable	PM: partly bio-based PMMA	HFS FC: high frequency sensor with corridor function	CG: cable gland

More options available:
 - Through wiring: 3x1.5mm², 3x2.5mm², 5x1.5mm², 5x2.5mm²
 - Fast connector

Operational data

Description	Reference	Luminous flux (lm)	Power (W)	Efficiency (lm/W)	Temperature range
NBHE 6 L 20-840 ET PM CG	10347435	2000	12	165	-30°C +40°C
NBHE 6 L 20-840 ETDD PM CG	10347436	2000	12	165	-30°C +40°C
NBHE 12 L 40-840 ET PM CG	10347438	4000	23,5	170	-30°C +40°C
NBHE 12 L 40-840 ETDD PM CG	10347439	4000	23,5	170	-30°C +40°C
NBHE 15 L 60-840 ET PM CG	10347443	6000	35	170	-30°C +40°C
NBHE 15 L 60-840 ETDD PM CG	10347444	6000	35	170	-30°C +40°C
HIGH FREQUENCY SENSOR					
NBHE 12 L 40-840 ET PM HFS FC CG	10347454	4000	24	167	-30°C +40°C
NBHE 15 L 60-840 ET PM HFS FC CG	10347455	6000	36	167	-30°C +40°C

Dimensions and logistics

Description	X (mm)	Xm (mm)	Y (mm)	Z (mm)	L x W x H (mm)	KG Item	Pcs./Box	KG Box ¹	Groupage Pcs./pallet	FTL/container Pcs./Double pallet
NBHE 6...	703	172 - 436	101	84	735 x 110 x 95	1.3	1	1.2	238	154 + 154
NBHE 12...	1265	396 - 1000	101	84	1300 x 110 x 95	1.8	1	2.1	119	77 + 77
NBHE 15...	1565	695 - 1300	101	84	1600 x 110 x 95	2.3	1	2.7	119	77 + 77

¹ Weight in ETDD versions: +0.2KG

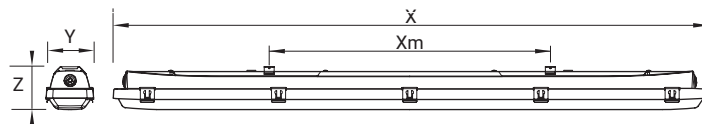

Accessories

Description	Reference	Description	Reference
Suspension wire 2m hook and fastener, 1 unit ²	10103049	ZBWM wall mounting accessory (allows luminaire rotation), 2 pieces set	10207593
Theft protection (required for wall mounting), set for 1 luminaire	10149442	Fixing clips in stainless steel 316L, 2 units	10256809

² 2 units required per luminaire

Estimated data as of printing date

The new tubular openable luminaire, extreme and flexible for every place

Usual applications:



Kitchen



Chemical



Car wash



High moisture

LUMINA



NEW



NAIPE ROCKA



ROCKA

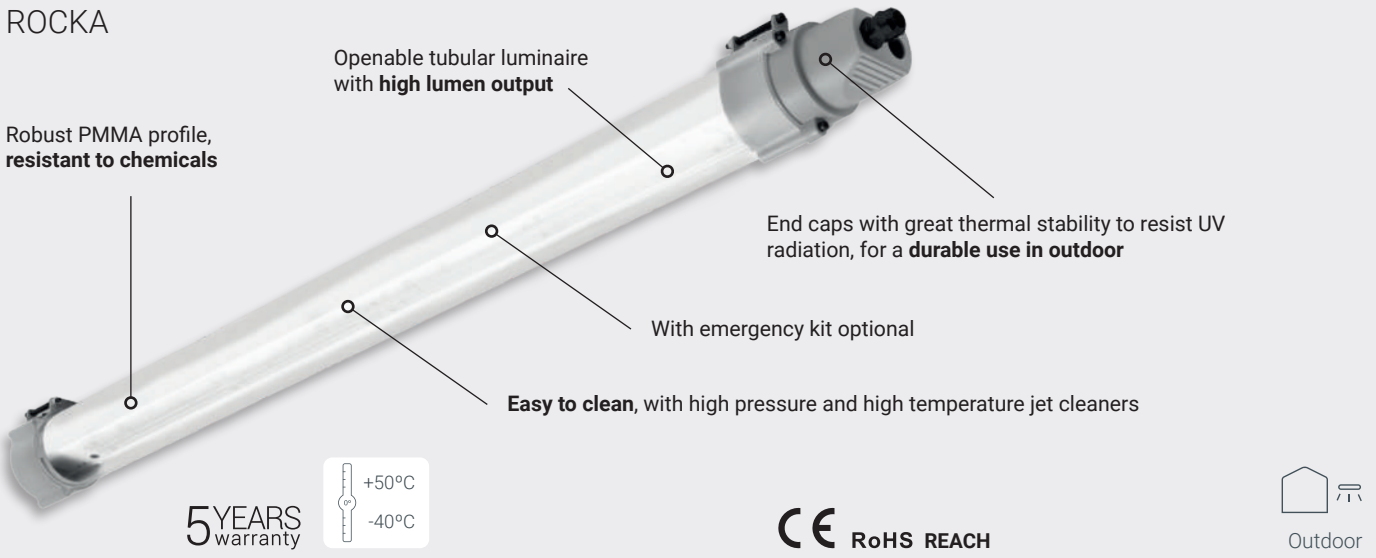

Characteristics

ROCKA

Mechanical	IP69(80°) IK10
Profile	High thickness PMMA with UV protection Clear finish
End caps	PA66 + fibreglass
Gasket	High-temperature resistant MVQ silicone
Gear tray	White lacquered steel plate + internal aluminum heatsink
Cable entry	Cable gland
Fixing clips	Stainless steel V2A

Functional

Lifetime	L80 100,000 hours at 35°C	
Fire protection	Flammability (UL94):	HB
	Glow wire test (EN 60595-2-11):	650°C

Electrical



Connection	3 pole push wire terminal block
Power factor	>0.95 full load
THD	10% full load
Flicker factor	>1%

Photometrical

Luminous flux	Up to 8000lm
Efficiency	158lm/W
SDCM	< 3

Polar diagram

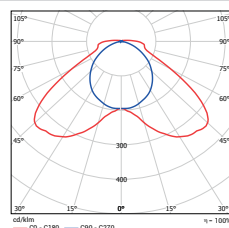

Applications



The demands of a professional kitchen are very extreme. It is essential to guarantee **high resistance** to the presence of humidity, grease, and high temperatures.

ROCKA offers optimal quality of light, with high chromatic reproduction, to guarantee **good working conditions**.



The installation of luminaires in **outdoor areas** requires **high resistance to environmental conditions** such as rain, wind, heat or UV radiation.

ROCKA's **robust finish** guarantees durability of up to 100,000 hours in demanding environments.

Options

Special options in grey under request

LENGTH (mm)	OPTICS	LUMINOUS FLUX (lm)	CRI	LIGHT COLOUR (K)	DRIVER	PROFILE	EMERGENCY KIT
0.6: 600	B: wide	20: 2000	8: >80	40: 4000	ET: non-dimmable	PMMA	EB3: 3 hours
1.2: 1200	XB: extensive	35: 3500	9: >90	27: 2700	ETDD: DALI dimmable		
1.5: 1500	TB: narrow	40: 4000		30: 3000			
1.8: 1800		60: 6000		50: 5000			
		65: 6500		57: 5700			
		80: 8000		65: 6500			
		100: 10000					

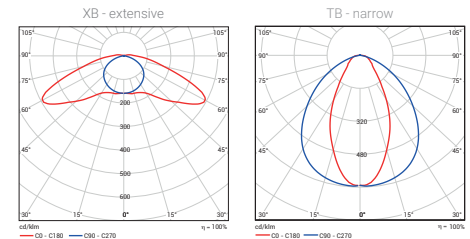

More options available:

- High frequency sensor (HFS)
- Through wiring: 3x1.5mm², 3x2.5mm², 5x1.5mm², 5x2.5mm²

Operational data

Description	Reference	Luminous flux (lm)	Power (W)	Efficiency (lm/W)	Luminous flux emergency (lm)	Temperature range
ROCKA 0.6 B 20-840 ET PMMA	10325356	2000	15	133	—	-25°C - +45°C
ROCKA 0.6 B 35-840 ET PMMA ¹	10325563	3500	25	140	—	-25°C - +40°C
ROCKA 1.2 B 40-840 ET PMMA	10325547	4000	27	148	—	-40°C - +50°C
ROCKA 1.2 B 65-840 ET PMMA	10325564	6500	43	151	—	-40°C - +45°C
ROCKA 1.5 B 60-840 ET PMMA	10325548	6000	38	158	—	-40°C - +50°C
ROCKA 1.5 B 80-840 ET PMMA	10325565	8000	52	154	—	-40°C - +45°C
EMERGENCY KIT						
ROCKA 0.6 B 20-840 ET PMMA EB3	10325566	2000	20	100	700	0°C - +40°C
ROCKA 1.2 B 40-840 ET PMMA EB3	10325567	4000	32	125	700	0°C - +45°C
ROCKA 1.5 B 60-840 ET PMMA EB3	10325568	6000	43	140	700	0°C - +45°C

¹ Lifetime L80 85,000 hours.

Dimensions and logistics

Description	X (mm)	Xm (mm)	Y (mm)	Z (mm)	L x W x H (mm)	Pcs./Box	KG Box	Groupage Pcs./pallet	FTL/container Pcs./Double pallet
ROCKA 0.6...	888	725	125	138	1010 x 160 x 140	1	3.6	50	30 + 30
ROCKA 1.2...	1451	1287	125	138	1600 x 160 x 140	1	5.3	50	30 + 30
ROCKA 1.5...	1732	1569	125	138	1900 x 160 x 140	1	6.2	50	30 + 30

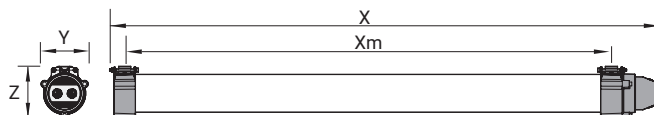

Innovative modular luminaire fully openable and adaptable: ready for the future

Usual applications:



High bay



Smart parking



Food



Automotive



Warehouse



Storage

LUMIN



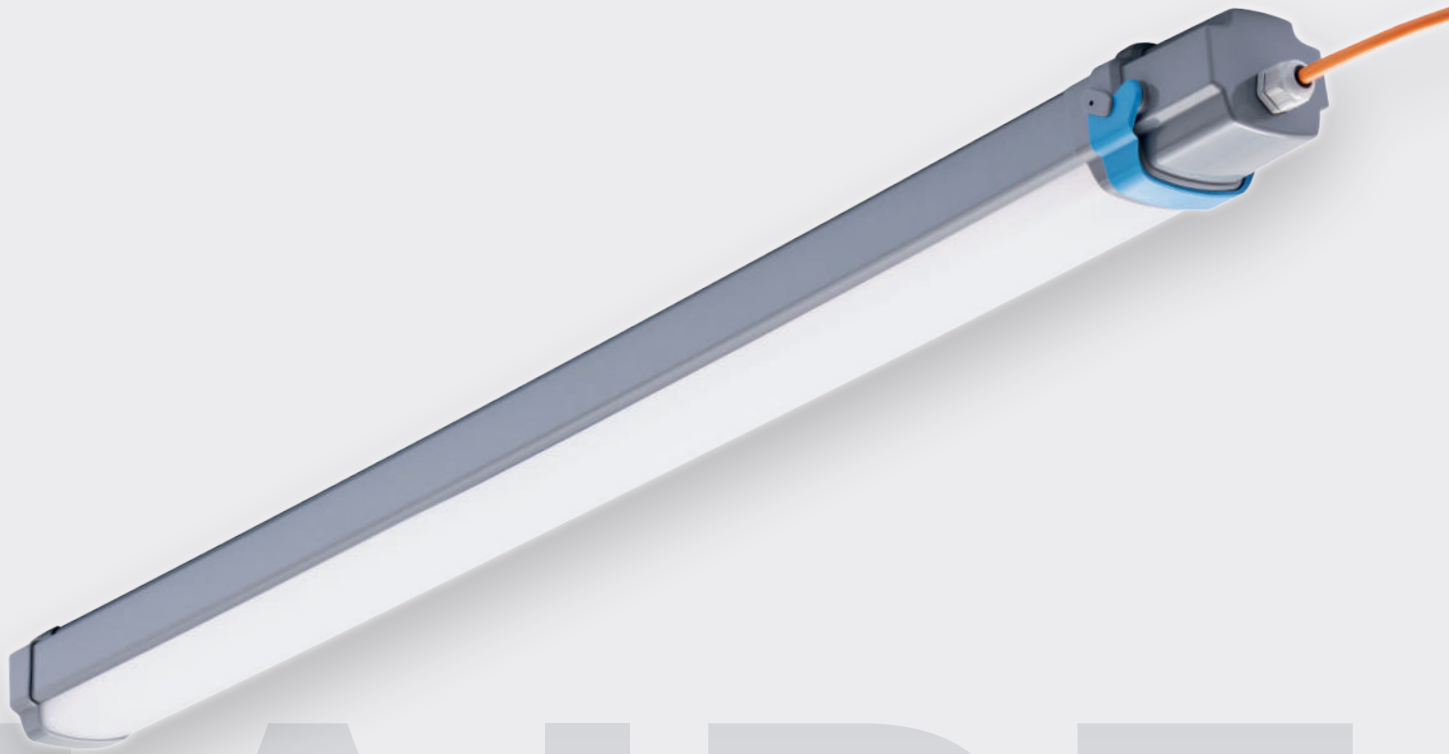

WALDRE

KE





Patented locking system with leva, with easy electro-mechanical connection; ready for vandal proof environments

Specific version with high chemical resistance
Under request

Up to 165 lm/W

Long lifetime up to 100,000 hours

Robust for a wide range of temperatures

5 YEARS warranty

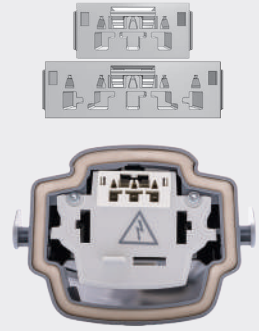

Up to 8 poles ready for through wiring, phase connection or emergency

Characteristics

KE

Mechanical

IP66 / IP69(80°) IK10

Profile	Opal extruded polycarbonate with UV protection Clear profile under request, recommended for optics Upper part dark grey RAL 7046
End caps	Injected polycarbonate
Lever	Injected polyamide 66 blue RAL 5012 Other customized colours under request
Gasket	Removable and recyclable thermoplastic elastomers
Gear tray	White lacquered steel plate
Cable entry	Cable gland
Fixing clips	Stainless steel

Functional

Lifetime	L80 100,000 hours at 35°C
Fire protection	Flammability (UL94): V2
	Glow wire test (EN 60595-2-11): 850°C

Electrical



Connection	3 to 8 poles WAGO quick connector
Power factor	>0.95 full load
THD	<10%
Flicker factor	<1%

Photometrical

Luminous flux	Up to 15,000lm
Efficiency	Up to 165lm/W
SDCM	< 3

Polar diagram

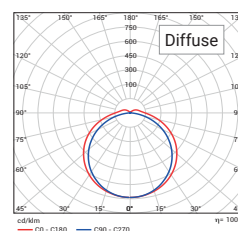

Applications



High bay



Smart parking



Food



Automotive



Warehouse



Storage



With up to **15,000lm** and **high efficiency**, KE ensures lux levels are met from high ceilings. Its **photometries**, such as **intensive optics**, help to provide the right light level from open areas to narrow aisles.

Luminaires can be easily installed in a **continuous line**, achieving up to 30,000lm over 3 meters with 2 light units. In a **15m height warehouse**, this means **> 120lux** on the floor¹.



Any car park distribution benefits from KE optics range, with **very extensive or asymmetric photometries** which adapt light to different needs.

Thanks to its modularity, external modules can be added to integrate **wireless connection and presence and daylight sensors** in the same luminaire profile.



Food production, processing and storage require from high to very low temperatures, so KE **wide temperature range** helps.

Safety and hygiene requirements are a must. KE is **certified under HACCP standards** and have a high protection degree **IK10 and IP69K**, which grants its resistance when using high pressure jet cleaners.

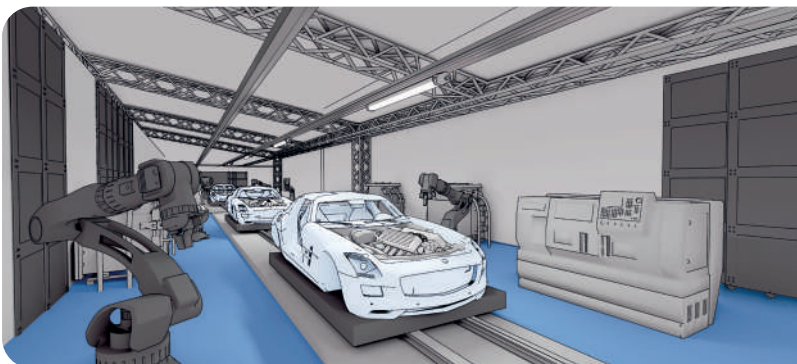

To guarantee a perfect finish in paint and coating areas, KE incorporates a **PWIS-free gasket**.

Its **easy electrical connection** can be made from the ground, which facilitates mounting in challenging areas. For a proper identification of car parts and to avoid assembling mistakes, it has **different colour temperatures and a high CRI**.

¹See case study with a continuous line installation on page 78

Options Special options in grey under request

LENGTH (mm)	OPTICS	LUMINOUS FLUX (lm)	CRI	LIGHT COLOUR (K)	DRIVER	PROFILE AND END CAPS	THROUGH WIRING	SENSOR	EMERGENCY KIT	TEMPERATURE RANGE
1.2: 1200	-: diffuse	40: 4000	8: >80	40: 4000	ET: non-dimmable	PC:	3x1.5mm ²	HFS: high frequency sensor	EB3: 3 hours	HT: up to 55°C
1.5: 1500	N: narrow	60: 6000	9: >90	30: 3000	ETDD: DALI dimmable	polycarbonate	5x2.5mm ²		EB1: 1 hour	
0.6: 600	VW: extensive XW: very extensive AW: asymmetric extensive AXW: asymmetric very extensive	80: 8000 100: 10000 ML: from 2000 to 10000 150: 15000		50: 5000 65: 6500	ETDD CS: Casambi dimmable ETD: 1-10V dimmable CLO: Constant Lumen Output HCL: Human Centric Lighting	PCC: resistant polycarbonate	3x1.5mm ² to 8x2.5mm ²		EB3 NDA: 3 hours DALI	

More options available:
 • Fast connector
 • Protection Class II

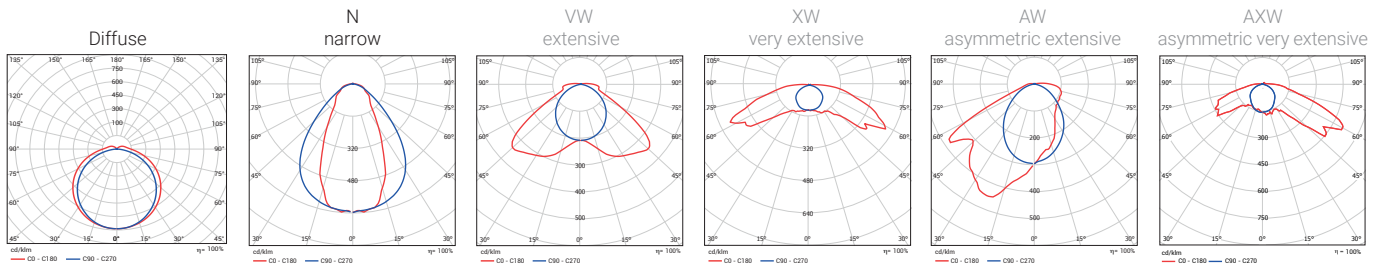

Modularity

Thanks to the innovative lever and end cap, it is **easy to open and close** KE luminaire for quick access to the gear tray, enabling the replacement of components such as emergency batteries, and continuous line connection.

This lever locking system is also **vandal-resistant** by simply placing a security screw.

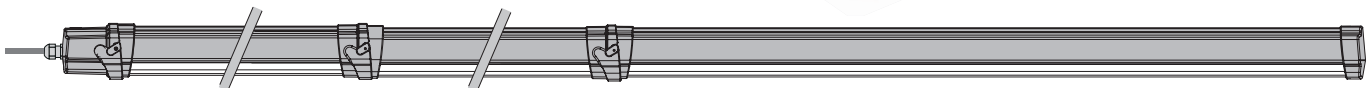

1. Continuous line lighting units¹

It is possible to connect **up to 15 lighting units in one line**, thanks to its through wiring ready for dimmable versions and the easy and quick locking system between profiles.

Description	Reference	Luminous flux (lm)	Power (W)	Compatible with
KHE 1.2 40-840 ET PC 3x1.5 LC	10278219	4000	26	KE ET / KE ET 3x1.5
KHE 1.5 60-840 ET PC 3x2.5 LC	10258555	6000	41	KE ET / KE ET 3x1.5
KHE 1.2 40-840 ET PC 5x2.5 LC	10284352	4000	26	KE ETDD / KE ETDD 5x2.5
KHE 1.5 60-840 ET PC 5x2.5 LC	10284353	6000	41	KE ETDD / KE ETDD 5x2.5

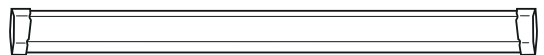

¹ Lighting units are supplied without end caps, so it is needed to include at least one complete luminaire in each line (see next page).

2. Additional modules²

Available modules help to improve installation energy efficiency:

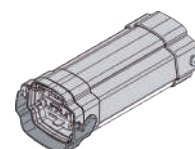

- **Wireless solution**, to control the lighting installation remotely and without the need of rewiring.
- **Presence and daylight sensor**, to use the light only where and when it is really needed.

Description	Reference	Feature	Compatible with
KE HFS-M UNIT	10251322	Presence and daylight sensor	KE ET / KE ET 3x1.5
KE CSMB ETDD UNIT	10258554	Wireless solution	KE ETDD / KE ETDD 5x2.5









² Additional modules are supplied without end caps, so it is needed to include at least one complete luminaire.

Operational data¹

Description	Reference	Luminous flux (lm)	Power (W)	Efficiency (lm/W)	Luminous flux emergency (lm)	Temperature range
KHE 1.2 40-840 ET PC	10223668	4000	26	155	—	-30°C - +45°C
KHE 1.2 40-840 ETDD PC	10223745	4000	26	155	—	-30°C - +45°C
KHE 1.2 40-840 ET PC 3x1,5	10223752	4000	26	155	—	-30°C - +40°C
KHE 1.2 40-840 ETDD PC 5x2.5	10223753	4000	26	155	—	-30°C - +35°C
KHE 1.2 40-840 ETDD CS PC	10223747	4000	26	155	—	-20°C - +35°C
KHE 1.2 40-840 ET CS PC	10223748	4000	27	150	—	-20°C - +35°C
KHE 1.2 40-840 ET PC ML	10223746	2000 - 6000	14 - 47	150	—	-30°C - +35°C
KHE 1.5 60-840 ET PC	10223754	6000	41	147	—	-30°C - +45°C
KHE 1.5 60-840 ETDD PC	10223755	6000	41	147	—	-30°C - +45°C
KHE 1.5 60-840 ET PC 3x1,5	10223762	6000	41	147	—	-30°C - +40°C
KHE 1.5 60-840 ETDD PC 5x2.5	10223763	6000	41	147	—	-30°C - +35°C
KHE 1.5 60-840 ETDD CS PC	10223757	6000	41	147	—	-20°C - +35°C
KHE 1.5 60-840 ET PC HFS	10223758	6000	42	145	—	-20°C - +35°C
KHE 1.5 60-840 ET PC ML	10223756	2500 - 10000	17 - 58	150	—	-30°C - +35°C
 EMERGENCY KIT						
KHE 1.2 40-840 ET PC EB3	10223749	4000	26	155	550	0°C - +35°C
KHE 1.5 60-840 ET PC EB3	10223759	6000	41	147	600	0°C - +35°C
 HIGH TEMPERATURE						
KHE 1.2 40-840 ET PC HT	10223750	4000	26	155	—	-40°C - +55°C
KHE 1.2 40-840 ETDD PC HT	10223751	4000	26	155	—	-40°C - +55°C
KHE 1.5 60-840 ET PC HT	10223760	6000	39	155	—	-40°C - +55°C
KHE 1.5 60-840 ETDD PC HT	10223761	6000	39	155	—	-40°C - +55°C
 HIGH BAY						
KHE 1.5 80-840 ET PC	10225374	8000	58	140	—	-30°C - +55°C
KHE 1.5 80-840 ETDD PC	10225375	8000	58	140	—	-30°C - +55°C
KHE 1.5 100-840 ET PC	10225062	10000	64	157	—	-40°C - +50°C
KHE 1.5 100-840 ETDD PC	10225064	10000	64	157	—	-40°C - +50°C
KHE 1.5 TB 100-840 ET PC	10225063	10000	64	157	—	-40°C - +50°C
KHE 1.5 TB 100-840 ETDD PC	10225065	10000	64	157	—	-40°C - +50°C
KHE 1.5 TB 100-840 ETDD PC HFS	10225066	10000	64	157	—	-20°C - +35°C

¹ Complete luminaires are supplied with an end cap including the cable gland on one side, and a blind end cap on the other side; except for the through wiring versions which include two end caps with cable glands.

Dimensions and logistics

Description	X (mm)	Xm (mm)	Y (mm)	Z (mm)	 L x W x H (mm)	 Item	 Pcs./Box	 Box	 Groupage Pcs./pallet	 FTL/container Pcs./Double pallet
KHE 1.2...	1372	800	117	95	1498 x 120 x 100	2.8	1	2.9	96	60 + 60
KHE 1.2... 3x1.5 / 5x2.5	1498	800	117	95	1498 x 120 x 100	3.0	1	3.1	96	60 + 60
KHE 1.5...	1664	1100	117	95	1790 x 120 x 100	3.5	1	3.6	96	60 + 60
KHE 1.5... 3x1.5 / 5x2.5	1790	1100	117	95	1790 x 120 x 100	3.7	1	3.8	96	60 + 60



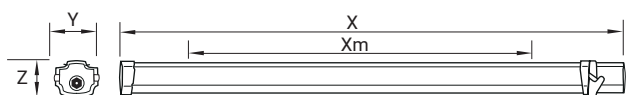

STANDARD VERSION

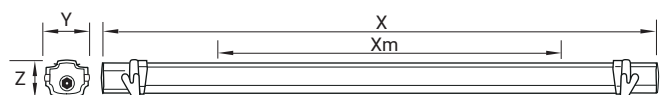

THROUGH WIRING VERSION



Accessories

Description	Reference
 Suspension wire 2m hook and fastener, 1 unit ²	10103049
 Theft protection (required for wall mounting), set for 1 luminaire	10149442
 ZBWM wall mounting accessory (allows luminaire rotation), 2 pieces set	10207593
 Fixing clips in stainless steel 316L, 2 units	10256809

² 2 units required per luminaire

Long-lasting, compact and resistant luminaire with easy installation

Usual applications:

ZALUX BASE HE PMMA



ZALUX BASE STP



ZALUX BASE D.O.



LUMINA

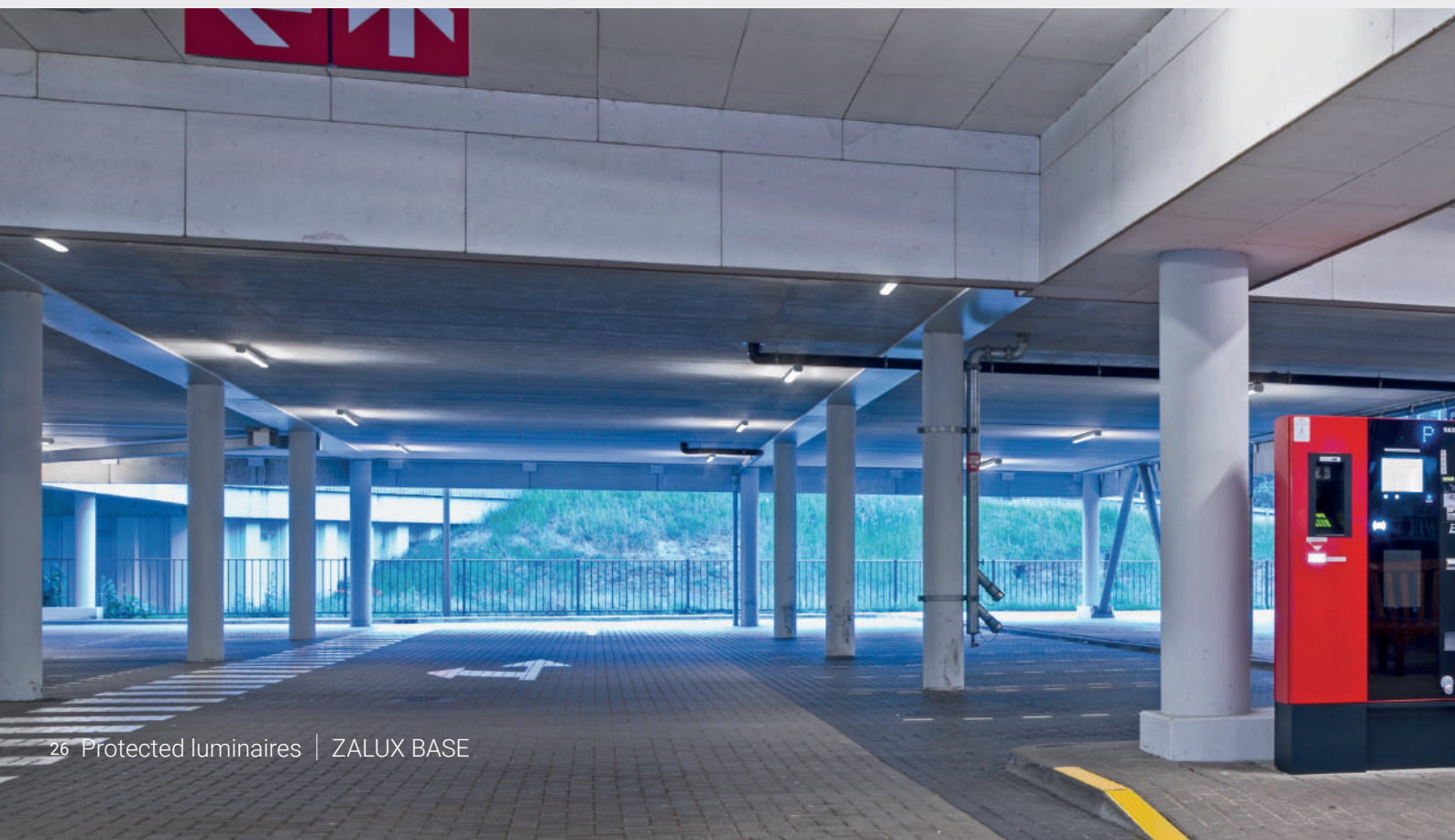

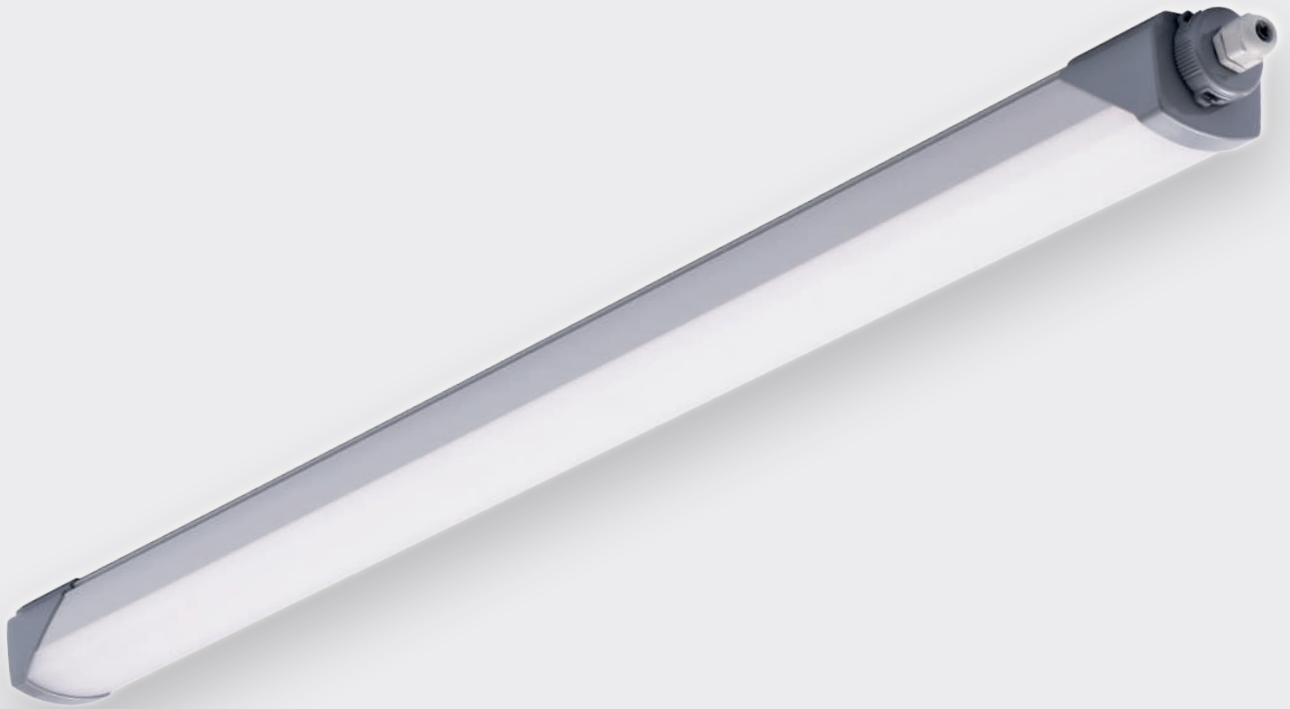

VAIREF

ZALUX BASE



ZALUX BASE HE PMMA

Extraordinary chemical resistance

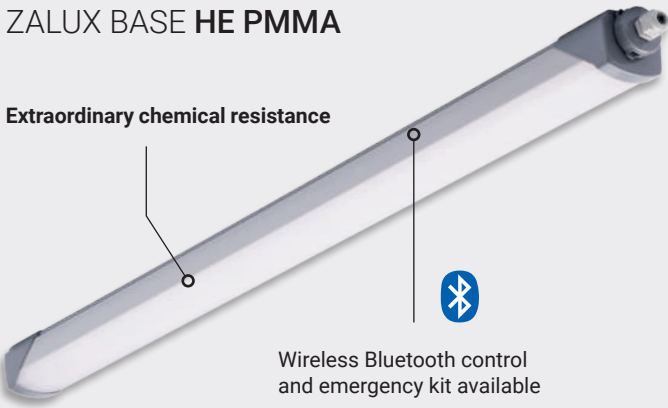

Wireless Bluetooth control and emergency kit available



5 YEARS warranty



ZALUX BASE STP

Higher impact resistance

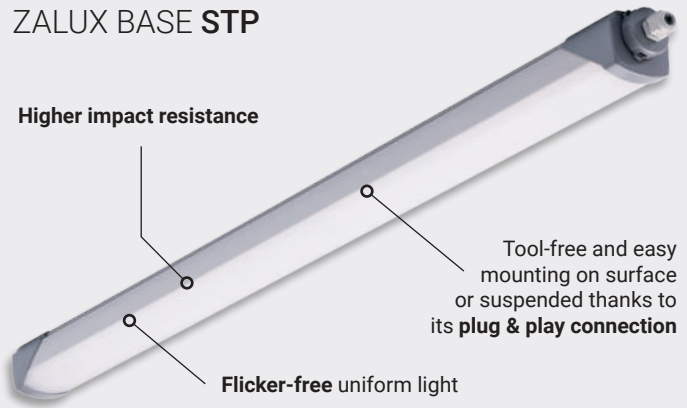

Flicker-free uniform light

Tool-free and easy mounting on surface or suspended thanks to its plug & play connection

5 YEARS warranty



Characteristics

	ZALUX BASE HE PMMA	ZALUX BASE STP
Mechanical	IP66 / IP69(80°) IK07	IP66 / IP69(80°) IK10
Housing	Extruded PMMA with UV protection Extruded polycarbonate with UV protection Upper part grey RAL 7035 Bottom part opal	
End caps	Acrylonitrile styrene acrylate (ASA)	Polycarbonate
Gasket	PWIS-free silicone	
Gear tray	White lacquered steel plate	
Cable entry	Cable gland	
Fixing clips	Stainless steel	
Suspension triangles	Stainless steel	

Functional

Lifetime	L80 70,000 hours	L80 50,000 hours
Fire protection	Flammability (UL94):	HB
	Glow wire test (EN 60595-2-11):	650°C
		V2
		850°C

Electrical

Connection	3/5 pole push wire terminal block		
Power factor	>0.95 full load		
THD	<10% full load		
Flicker factor	<1%		



Frequency
0-50/60Hz

Rated Voltage
220-240V

NON-SELV

Photometrical

Luminous flux	Up to 8,000lm	Up to 6,000lm
Efficiency	Up to 135lm/W	Up to 125lm/W
SDCM	< 3	

Polar diagram

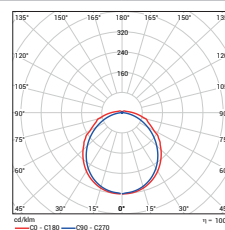

Applications

ZALUX BASE HE PMMA

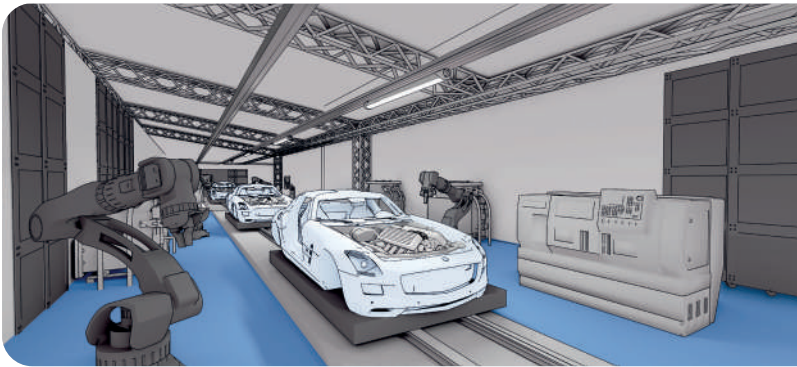

In automotive production areas with chemical elements, **resistant** luminaires are required. ZALUX BASE HE PMMA has a PMMA body and **PWIS-free silicone** without substances that adhere to automotive paintwork, and provides an **extraordinary lighting quality**.



Ammonia is usually present in farms. ZALUX BASE HE PMMA chemical resistant body offers **resistance to acids or sulphur vapours** and prevent the ingress of corrosive chemicals. With **IP69K**, it is appropriate for deep cleaning with jet cleaners. Also, **1-10V dimming** is available.

ZALUX BASE STP



ZALUX BASE STP is a flicker-free luminaire with no glare nor visible spots, with a neutral white light and CRI 80 to provide **high visual comfort**. It helps people feel more comfortable and be seen better by drivers and CCTV, creating a **safe environment**.



From warehouses to auxiliary areas, ZALUX BASE STP fits in more projects thanks to its **tool-less installation** and a flexible mounting on surface or suspended. With a compact design, it provides great **uniform lighting with up to 125lm/W**.

ZALUX BASE HE PMMA

LENGTH (mm)	LUMINOUS FLUX (lm)	CRI	LIGHT COLOUR (K)	DRIVER	PROFILE	THROUGH WIRING
1.2: 1200	40: 4000	8: >80	40: 4000	ET: non dimmable	BPM: PMMA	3x1.5mm ²
1.5: 1500	60: 6000	9: >90	30: 3000	ETDD: DALI dimmable		5x2.5mm ² L1: connected to phase 1
0.6: 600	2000 to 8000		65: 6500 827-865: tunable white	ETDD CS: Casambi dimmable ETDD CLO: Constant Lumen Output		3x2.5 mm ² 5x1.5 mm ² 5x2.5mm ²

More options available:

- High frequency sensor (HFS)
- Fast connector
- Customized ends caps: colour, printed logo...
- Efficiency: up to 150 lm/W
- Emergency kit: 1 hour (EB1) or 3 hours (EB3)

ZALUX BASE STP

LENGTH (mm)	LUMINOUS FLUX (lm)	CRI	LIGHT COLOUR (K)	DRIVER	PROFILE	THROUGH WIRING
0.6: 600	20: 2000	8: >80	40: 4000	ET: non dimmable	BPC: polycarbonate	3x1.5mm ²
1.2: 1200	40: 4000	9: >90	30: 3000	ETDD: DALI dimmable	BPM: PMMA	5x1.5mm ²
1.5: 1500	60: 6000		65: 6500			3x2.5mm ²
0.9: 900	2000 to 6000					5x2.5mm ² 5x2.5mm ² L1 connected to phase 1

More options available:

- Emergency kit: 1 hour (EB1) or 3 hours (EB3)

ZALUX BASE incorporates a piece that positions the connection plug during the electrification of the luminaire and allows the luminaire to be protected when it is closed.

It also includes a bayonet cap for **quick access to the plug connector**, which makes electrical connection easier.



Operational data

ZALUX BASE HE PMMA

Description	Reference	Luminous flux (lm)	Power (W)	Efficiency (lm/W)	Temperature range
BHE 1.2 40-840 ET BPM	10181648	4000	29	135	-25°C - +45°C
BHE 1.2 40-840 ET BPM 3X1,5	10181649	4000	29	135	-25°C - +40°C
BHE 1.2 40-840 ET BPM 5X2,5 L1	10181650	4000	29	135	-25°C - +35°C
BHE 1.2 40-840 ETDD BPM	10266164	4000	29	135	-25°C - +45°C
BHE 1.5 60-840 ET BPM	10181651	6000	44	135	-25°C - +45°C
BHE 1.5 60-840 ET BPM 3X1,5	10181652	6000	44	135	-25°C - +40°C
BHE 1.5 60-840 ET BPM 5X2,5 L1	10181653	6000	44	135	-25°C - +35°C
BHE 1.5 60-840 ETDD BPM	10266165	6000	44	135	-25°C - +45°C

ZALUX BASE STP

Description	Reference	Luminous flux (lm)	Power (W)	Efficiency (lm/W)	Temperature range
BSTP 0.6 20-840 ET BPC	10171115	2000	17	120	-25°C - +40°C
BSTP 1.2 40-840 ET BPC	10171116	4000	32	125	-25°C - +40°C
BSTP 1.2 40-840 ET BPC 3x1.5	10171117	4000	32	125	-25°C - +35°C
BSTP 1.2 40-840 ETDD BPC	10175406	4000	32	125	-25°C - +40°C
BSTP 1.2 40-840 ET BPC 5x1.5	10221087	4000	32	125	-25°C - +35°C
BSTP 1.5 60-840 ET BPC	10171118	6000	51	120	-25°C - +40°C
BSTP 1.5 60-840 ET BPC 3x1.5	10171119	6000	51	120	-25°C - +35°C
BSTP 1.5 60-840 ETDD BPC	10221088	6000	51	120	-25°C - +40°C
BSTP 1.5 60-840 ET BPC 5x1.5	10221089	6000	51	120	-25°C - +35°C



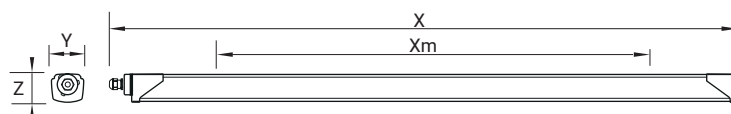

Dimensions and logistics

Description	X (mm)	Xm (mm)	Y (mm)	Z (mm)	L x W x H (mm)	KG Item	Pcs./Box	KG Box ¹	Groupage Pcs./pallet	FTL/container Pcs./Double pallet
BHE / BSTP 0.6...	637	350	76	67	790 x 85 x 75	1.0	1	1.1	342	216 + 216
BHE / BSTP 1.2...	1213	800	76	67	1330 x 85 x 75	1.8	1	1.9	171	108 + 108
BHE / BSTP 1.5...	1493	1100	76	67	1610 x 85 x 75	2.2	1	2.3	171	108 + 108

¹ Weight in ETDD versions: +0.2KG



Accessories

Description	Reference
 Suspension wire 2m hook and fastener, 1 unit ²	10103049
 Theft protection (required for wall mounting), set for 1 luminaire	10149442
 ZBWM wall mounting accessory (allows luminaire rotation), 2 pieces set	10207593
 Fixing clips in stainless steel 316L, 2 units	10256809

² 2 units required per luminaire

ZALUX BASE D.O.

Certified by the Champagne Committee

Specific amber LED with very narrow spectrum

Protects wine and champagne against riboflavin effects from photosensitivity

Resistant to high ambient humidity



Suitable for cellars: qualified by an independent laboratory

5 YEARS warranty



Characteristics

ZALUX BASE D.O.

Mechanical

IP66 / IP69(80°) IK10

Profile	Extruded polycarbonate with UV protection Upper part grey RAL 7035 Bottom part opal
End caps	Polycarbonate
Gasket	PWIS-free silicone
Gear tray	White lacquered steel plate
Cable entry	Cable gland
Fixing clips	Stainless steel
Suspension triangles	Stainless steel

Functional

Lifetime	L80 50,000 hours
Fire protection	Flammability (UL94): V2
	Glow wire test (EN 60595-2-11): 850°C

Electrical



Connection	3/5 pole push wire terminal block
Power factor	>0.95 full load
THD	<10% full load
Flicker factor	<1%

Photometrical

Luminous flux	Up to 2,400lm
SDCM	< 3

Polar diagram

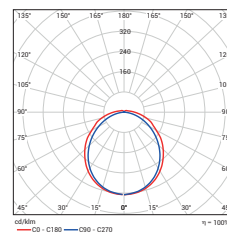

Applications



Cellar



Wine and champagne are negatively affected by light, due to UV rays and heat. **Riboflavin** produced during alcoholic fermentation absorbs part of the energy emitted by light sources and unleash chemical reactions that lead to deviations in its sensory profile.

The **specific amber narrow spectrum** of ZALUX BASE D.O. take care of its natural properties, protecting them against photosensitivity.

Options Special options in grey under request.

LENGTH (mm)	LUMINOUS FLUX (lm)	LIGHT COLOUR (K)	DRIVER	PROFILE
0.6: 600	12: 1200	YEL: amber	ET: non dimmable	BPC: polycarbonate
1.2: 1200	24: 2400		ETDD: DALI dimmable	BPM: PMMA
0.3: 300				
0.9: 900				
1.5: 1500				

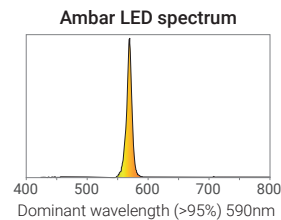

More options available:

- Through wiring: 3x1.5mm², 3x2.5mm², 5x1.5mm², 5x2.5mm²
- Fast connector
- Customized ends caps: colour, printed logo...

Operational data

Description	Reference	Luminous flux (lm)	Power (W)	Temperature range
BDO 0.6 12-YEL ET BPC	10215958	1200	34	-25°C - +35°C
BDO 0.6 12-YEL ETDD BPC	10215959	1200	34	-25°C - +35°C
BDO 1.2 24-YEL ET BPC	10215960	2400	68	-25°C - +35°C
BDO 1.2 24-YEL ETDD BPC	10215961	2400	68	-25°C - +35°C

Dimensions and logistics

Description	X (mm)	Xm (mm)	Y (mm)	Z (mm)	L x W x H (mm)	KG Item	Pcs./Box	KG Box ¹	Groupage Pcs./pallet	FTL/container Pcs./Double pallet
BDO 0.6...	637	350	76	67	790 x 85 x 75	1.0	1	1.1	342	216 + 216
BDO 1.2...	1213	800	76	67	1330 x 85 x 75	1.8	1	1.9	171	108 + 108

¹ Weight in 1.2 ETDD versions: +0.2KG

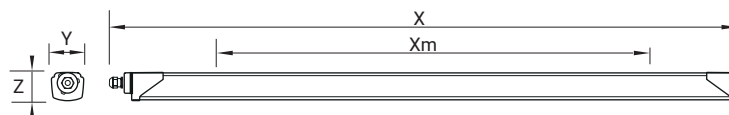

Accessories

Description	Reference	Description	Reference
Suspension wire 2m hook and fastener, 1 unit ²	10103049	ZBWM wall mounting accessory (allows luminaire rotation), 2 pieces set	10207593
Theft protection (required for wall mounting), set for 1 luminaire	10149442	Fixing clips in stainless steel 316L, 2 units	10256809

² 2 units required per luminaire

The sustainable, compact and profitable luminaire Made in Spain

Usual applications:



Corridor



Parking



Warehouse



Workshop

LUMINA





NAIRE IBERA



IBERA

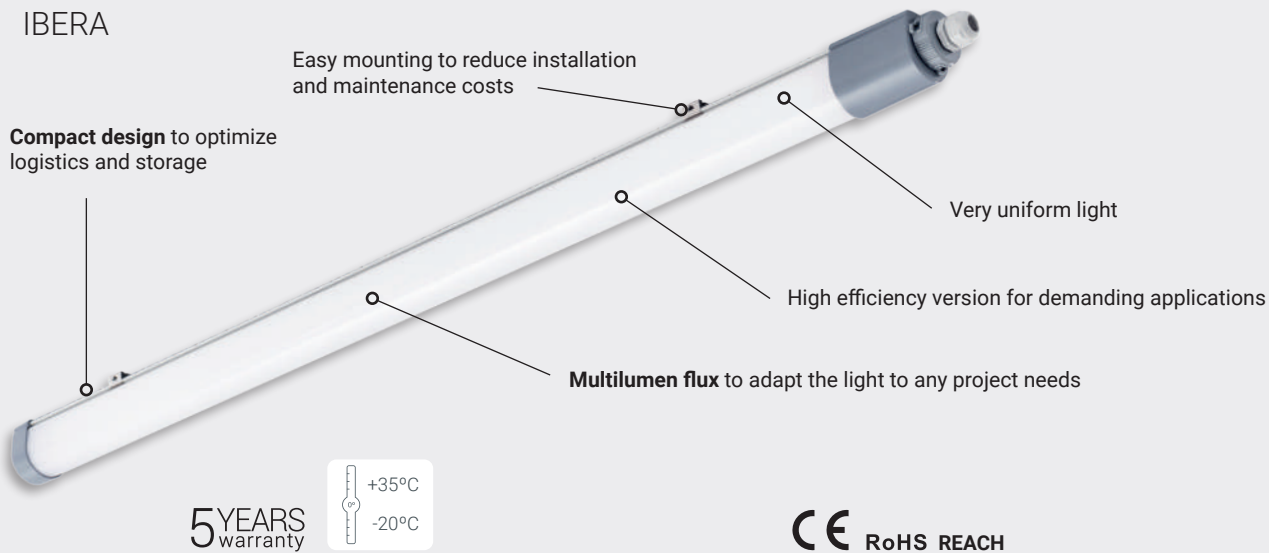

Characteristics

IBERA

Mechanical

IP66 IK08

Profile	Extruded polycarbonate with UV protection Upper part grey RAL 7035 Bottom part opal
End caps	Injected polycarbonate
Gasket	PWIS-free silicone
Cable entry	Cable gland
Fixing clips	Stainless steel Optional: polyamide
Suspension triangles	Stainless steel

Functional

Lifetime	L70 50,000 hours
Fire protection	Flammability (UL94): V2
	Glow wire test (EN 60595-2-11): 850°C

Electrical



Connection	3 pole screwless connector
Power factor	>0.95 full load
THD	<1.5%
Flicker factor	Flicker free

Photometrical

Luminous flux	Up to 6600lm
Efficiency	143lm/W
SDCM	< 4
Polar diagram	

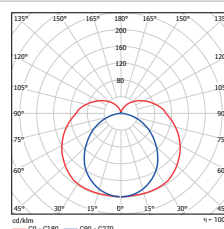

This photometry provides some indirect light, which avoids, for example, the cave effect in corridors.

Applications



Corridor



Parking



Warehouse



Workshop



Factory



Logistics

Do you want to discover more about IBERA?
Scan here!



For auxiliary areas, IBERA offers high IP66 and IK08 protection with quick, easy and tool-less installation. A reliable and compact luminaire **Made in Spain** which also helps to save transport and storage costs.

Options

LENGTH (mm)	LUMINOUS FLUX (lm)	CRI	LIGHT COLOUR (K)	DRIVER	PROFILE	THROUGH WIRING
0.6: 600 1.2: 1200 1.5: 1500	12-19: 1200 to 1900 25-39: 2500 to 3900 27-43: 2700 to 4300 33-47: 4700 to 6600 43-61: 4300 to 6100	8: >80	40: 4000	ET: non dimmable	PC: polycarbonate	3x1.5mm ²

Operational data

Description	Reference	Luminous flux (lm) ¹	Power (W)	Efficiency (lm/W)	Temperature range
IBERA 0.6 12-19-840 ET PC ²	10349815	1200 - 1900	20 - 30	130	-20°C - +35°C
IBERA 0.6 12-19-840 ET PC 3X1.5 ²	10349816	1200 - 1900	20 - 30	130	-20°C - +35°C
IBERA 1.2 25-39-840 ET PC	10263147	2500 - 3900	20 - 30	130	-20°C - +35°C
IBERA 1.2 25-39-840 ET PC 3X1.5	10263148	2500 - 3900	20 - 30	130	-20°C - +35°C
IBERA 1.5 43-61-840 ET PC	10263149	4300 - 6100	33 - 47	130	-20°C - +35°C
IBERA 1.5 43-61-840 ET PC 3X1.5	10263150	4300 - 6100	33 - 47	130	-20°C - +35°C
HIGH EFFICIENCY					
IBERA+ 1.2 27-43-840 ET PC	10335126	2700 - 4300	19 - 30	143	-20°C +35°C
IBERA+ 1.5 47-66-840 ET PC	10335127	4700 - 6600	33 - 47	142	-20°C +35°C

¹ Luminaire is supplied adjusted at the highest luminous flux

² Estimated data

Dimensions and logistics

Description	X (mm)	Xm (mm)	Y (mm)	Z (mm)	L x W x H (mm)	Pcs./Box	KG Box	Groupage Pcs./pallet	FTL/container Pcs./Double pallet
IBERA 0.6...	640	350	58	63	750 x 70 x 70	1	0.50	tbc	tbc
IBERA 1.2...	1240	800	58	63	1300 x 59 x 63	1	0.80	253	154 + 154
IBERA 1.5...	1640	1100	58	63	1600 x 59 x 63	1	0.95	253	154 + 154

Estimated data, please check with our Sales Back Office team to confirm dimensions and logistic data

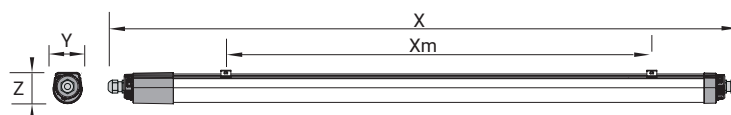

5 models give you the complete flexibility, from basic to highly demanding applications

Usual applications:

DUNA FLEX
HE HIGH BAY

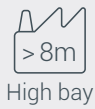

DUNA FLEX
ST



DUNA FLEX
HE+



DUNA BIO



DUNA FLEX
STP



DUNA FLEX





VAIPIRE

DUNA FLEX



DUNA FLEX HE HIGH BAY

DUNA FLEX HE+

Up to 15,000lm for the highest installations



Linear openable high bay with up to 170lm/W

PMMA and GRP for high chemical resistance



Optional wireless Bluetooth control and sensors for data monitoring

5 YEARS warranty



5 YEARS warranty



Characteristics

DUNA FLEX HE HIGH BAY

DUNA FLEX HE+

Mechanical

IP66 IK03

Housing	Compressed fibreglass reinforced polyester (GRP) Grey RAL 7035
Diffuser	Injected PMMA with UV protection, frosted finish (20% opal)
Closing clips	Stainless steel
Gasket	Polyurethane
Gear tray	White lacquered steel plate
Cable entry	Cable gland
Fixing clips	Stainless steel
Suspension triangles	Stainless steel

Functional

Lifetime	L80 100,000 hours at 35°C
Fire protection	Flammability (UL94): HB
	Glow wire test (EN 60595-2-11): 650°C

Electrical



Connection	3/5 pole push wire terminal block	
Power factor	>0.95 full load	
THD	<7% full load <10% full load for 8,000lm version	<10% full load
Flicker factor	<1%	

Photometrical

Luminous flux	Up to 15,000lm	Up to 6,000lm
Efficiency	Up to 170lm/W	160lm/W
SDCM	< 3	

Polar diagram

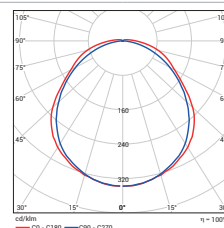

Applications

DUNA FLEX HE HIGH BAY



High bay



Aviation



Warehouse



Storage



Logistics

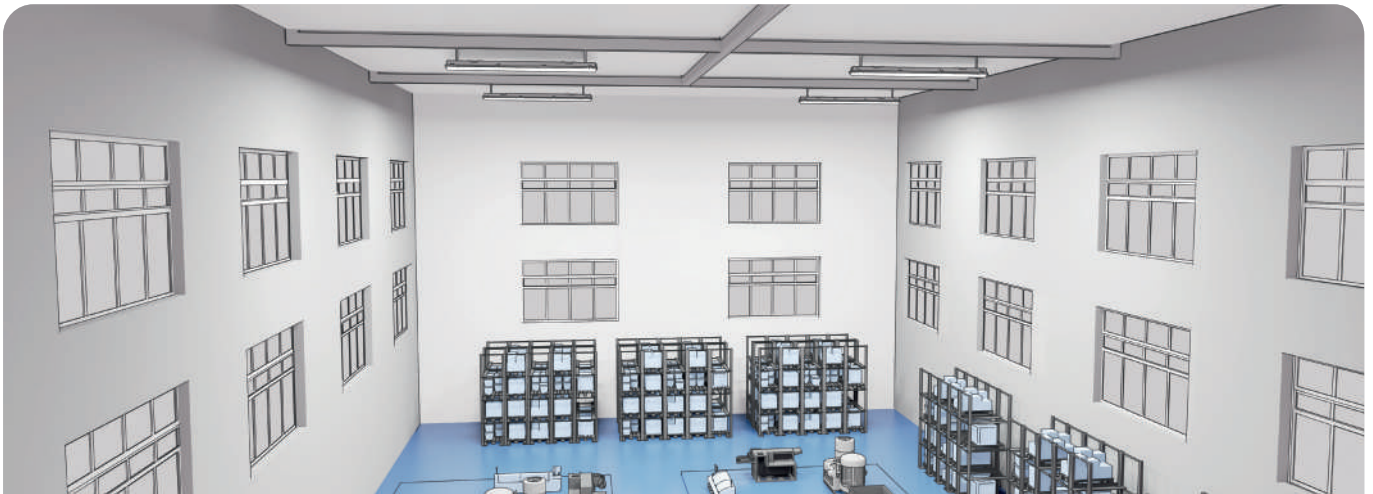

High bay applications require a luminous package ready to provide the needed light from the highest areas. DUNA FLEX HE HIGH BAY is an openable linear high bay luminaire with up to 15,000lm and 170lm/W and a wide temperature range. Its different optics available includes an intensive photometry suitable for high ceilings¹.

DUNA FLEX HE+



Food



Logistics



Storage



Factory



Warehouse



Thanks to its HACCP certification, DUNA FLEX HE+ can be used safely in places where foodstuffs are processed, handled and packed.

Its high chemical resistance contributes to process security, and thanks to its extended lifetime up to 100,000 hours, it illuminates better during a longer time.

¹ See warehouse case study on page 62.

DUNA FLEX HE HIGH BAY

LENGTH (mm)	LUMINOUS FLUX (lm)	CRI	LIGHT COLOUR (K)	DRIVER	HOUSING	DIFFUSER	CLOSING CLIPS	CONNECTION	THROUGH WIRING	EMERGENCY KIT
1.5: 1500	80: 8000 100: 10000 150: 15000	8: >80 9: >90	40: 4000 30: 3000 65: 6500 827-865: tunable white	ET: non dimmable ETDD: DALI dimmable ETDD CS: Casambi dimmable ETD: 1-10V ETDD CLO: Constant Lumen Output	SMC: GRP PC: PC	DPM: PMMA DPC: PC	IX: stainless steel PA: polyamide	CG: cable gland + terminal block TWW: Wieland fast connector TWS: Stucchi fast connector	3x1.5mm ² 5x2.5mm ² 5x1.5mm ²	EB3: 3 hours EB1: 1 hour EB3 NDA: 3 hours DALI

More options available: · High frequency sensor (HFS)
· Optics: narrow (TB), wide (XB) or extreme wide (MXB)

DUNA FLEX HE+

LENGTH (mm)	LUMINOUS FLUX (lm)	CRI	LIGHT COLOUR (K)	DRIVER	HOUSING	DIFFUSER	CLOSING CLIPS	CONNECTION	THROUGH WIRING	SENSOR	EMERGENCY KIT
1.2: 1200 1.5: 1500	40: 4000 60: 6000 MF: multilumen 2000 to 8000	8: >80 9: >90	40: 4000 30: 3000 65: 6500 827-865: tunable white	ET: non dimmable ETDD: DALI dimmable ETDD CS: Casambi dimmable ETD: 1-10V ETDD CLO: Constant Lumen Output	SMC: GRP PC: PC	DPM: PMMA DPC: PC	IX: stainless steel PA: polyamide	CG: cable gland + terminal block TWW: Wieland fast connector TWS: Stucchi fast connector	3x1.5mm ² 5x2.5mm ² 5x1.5mm ²	HFS: high frequency sensor	EB3: 3 hours EB1: 1 hour EB3 NDA: 3 hours DALI

More options available: · Optics: narrow (TB), wide (XB) or extreme wide (MXB)

TB - narrow

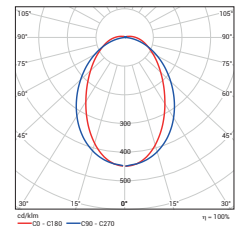

Internal diffuser to avoid direct contact with LED: protection without risk of damage by ESD



Flexible mounting on surface or suspended



Operational data







DUNA FLEX HE HIGH BAY

Description	Reference	Luminous flux (lm)	Power (W)	Efficiency (lm/W)	Luminous flux emergency (lm)	Temperature range
DHE 1.5 80-840 ET SMC DPM IX CG	10172636	8000	51	160	—	-30°C - +45°C
DHE 1.5 80-840 ET SMC DPM IX CG 3x1,5	10172637	8000	51	160	—	-30°C - +45°C
DHE 1.5 80-840 ET SMC DPM IX CG 5x2.5	10175691	8000	51	160	—	-30°C - +35°C
DHE 1.5 80-840 ETDD SMC DPM 5x2,5 CG IX	10175964	8000	51	160	—	-30°C - +35°C
DHE 1.5 80-840 ET SMC DPM IX CG HFS	10243157	8000	51	160	—	-20°C - +35°C
DHE 1.5 100-840 ET SMC DPM IX CG	10176408	10000	59	170	—	-40°C - +50°C
DHE 1.5 100-840 ET SMC DPM IX CG 3x1.5	10203626	10000	59	170	—	-40°C - +45°C
DHE 1.5 100-840 ET SMC DPM IX CG 5x2.5	10181019	10000	59	170	—	-40°C - +40°C
DHE 1.5 100-840 ETDD SMC DPM 5x2,5 CG IX	10195391	10000	59	170	—	-40°C - +40°C
DHE 1.5 150-840 ET SMC DPM IX CG	10232865	15000	95	160	—	-40°C - +35°C
DHE 1.5 150-840 ET SMC DPM 5X2.5 IX CG	10238243	15000	95	160	—	-40°C - +30°C
DHE 1.5 150-840 ET TB SMC DPM IX CG	10258499	15000	95	160	—	-40°C - +35°C
 EMERGENCY KIT						
DHE 1.5 80-840 ET SMC DPM EB1 CG IX	10202888	8000	51	160	880	0°C - +35°C
DHE 1.5 80-840 ET SMC DPM EB3 CG IX	10201997	8000	51	160	880	0°C - +35°C

DUNA FLEX HE+

Description	Reference	Luminous flux (lm)	Power (W)	Efficiency (lm/W)	Luminous flux emergency (lm)	Temperature range
DHE+ 1.2 40-840 ET SMC DPM IX CG	10203607	4000	25	160	—	-30°C - +50°C
DHE+ 1.2 40-840 ET SMC DPM IX CG 3x1,5	10203609	4000	25	160	—	-30°C - +45°C
DHE+ 1.2 40-840 ET SMC DPM 5X2.5 CG IX	10234099	4000	25	160	—	-30°C - +40°C
DHE+ 1.2 40-840 ETDD SMC DPM IX CG	10203608	4000	25	160	—	-30°C - +50°C
DHE+ 1.2 40-840 ETDD SMC DPM IX CG 5x2.5	10203610	4000	25	160	—	-30°C - +40°C
DHE+ 1.2 40-840 ET SMC DPM IX CG HFS	10203612	4000	25	160	—	-20°C - +35°C
DHE+ 1.2 40-840 ETDD CS SMC DPM IX CG	10214670	4000	25	160	—	-20°C - +35°C
DHE+ 1.2 40-840 ETDD CS SMC DPM IX CG HFS	10214672	4000	25	160	—	-20°C - +35°C
DHE+ 1.5 60-840 ET SMC DPM IX CG	10203617	6000	37	160	—	-30°C - +50°C
DHE+ 1.5 60-840 ET SMC DPM IX CG 3x1,5	10203619	6000	37	160	—	-30°C - +45°C
DHE+ 1.5 60-840 ET SMC DPM 5X2.5 CG IX	10234100	6000	37	160	—	-30°C - +40°C
DHE+ 1.5 60-840 ETDD SMC DPM IX CG	10203618	6000	37	160	—	-30°C - +50°C
DHE+ 1.5 60-840 ETDD SMC DPM IX CG 5x2.5	10203620	6000	37	160	—	-30°C - +40°C
DHE+ 1.5 60-840 ET SMC DPM IX CG HFS	10203622	6000	37	160	—	-20°C - +35°C
DHE+ 1.5 60-840 ETDD CS SMC DPM IX CG	10214671	6000	37	160	—	-20°C - +35°C
DHE+ 1.5 60-840 ETDD CS SMC DPM IX CG HFS	10214676	6000	37	160	—	-20°C - +35°C
 EMERGENCY KIT						
DHE+ 1.2 40-840 ET SMC DPM IX CG EB3	10203611	4000	25	160	650	0°C - +35°C
DHE+ 1.5 60-840 ET SMC DPM IX CG EB3	10203621	6000	37	160	680	0°C - +35°C

Dimensions and logistics

Description	X (mm)	Xm (mm)	Y (mm)	Z (mm)	 L x W x H (mm)	 Item	 Pcs./Box	 Box ¹	 Groupage Pcs./pallet	 FTL/container Pcs./Double pallet
DHE+ 1.2...	1283	800	101	84	1384 x 104 x 84	1.8	1	1.8	119	77 + 77
DHE / DHE+ 1.5...	1573	1100	101	84	1646 x 104 x 84	2.3	1	2.3	119	77 + 77

¹ Weight in EB3 versions: +0.2KG

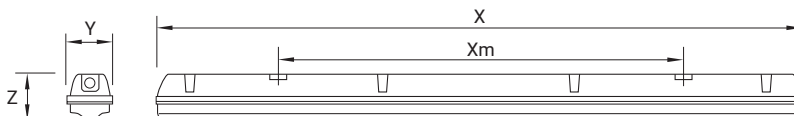

Accessories

Description	Reference	Description	Reference
 Suspension wire 2m hook and fastener, 1 unit ²	10103049	 ZBWM wall mounting accessory (allows luminaire rotation), 2 pieces set	10207593
 Theft protection (required for wall mounting), set for 1 luminaire	10149442	 Fixing clips in stainless steel 316L, 2 units	10256809

² 2 units required per luminaire

DUNA FLEX STP

First-class raw materials
safe against premature
deterioration

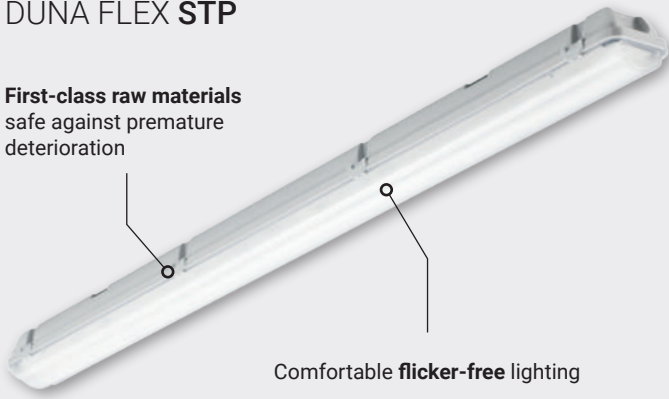

Comfortable **flicker-free** lighting

5 YEARS
warranty



DUNA FLEX ST

High protection against impacts



Unremovable plastic closing clips
for enhanced safety

3 YEARS
warranty



Characteristics

	DUNA FLEX STP	DUNA FLEX ST
Mechanical	IP66 IK08	
Housing	Injected polycarbonate with UV protection. Grey RAL 7035	
Diffuser	Injected PMMA with UV protection, frosted finish (20% opal)	
Closing clips	Polyamide 6 removable, or Stainless steel unremovable	Polyamide 6 unremovable
Gasket	Polyurethane	
Gear tray	White lacquered steel plate	
Cable entry	Grommet	
Fixing clips	Stainless steel	
Suspension triangles	Stainless steel	

Functional

Lifetime	L80 50.000 hours	L70 35,000 hours
Fire protection	Flammability (UL94):	V2
	Glow wire test (EN 60595-2-11):	850°C

Electrical



Connection	3/5 pole push wire terminal block	3 pole push wire terminal block
Power factor	>0.95 full load	>0.90 full load
THD	<10% full load	<20% full load
Flicker factor	<1%	5%

Photometrical

Luminous flux	Up to 6,000lm	Up to 6,100lm
Efficiency	Up to 145lm/W	130lm/W
SDCM	< 3	< 4

Polar diagram

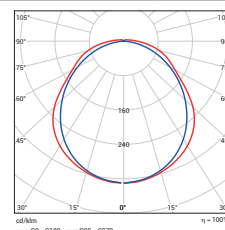

Applications

DUNA FLEX STP



Outdoor under shelter installations require reliable luminaires with high resistance to weather conditions, at least IP66. DUNA FLEX STP with its unremovable stainless steel or plastic closing clips provide enhanced safety, with a great lighting package up to 6,000lm.

DUNA FLEX ST

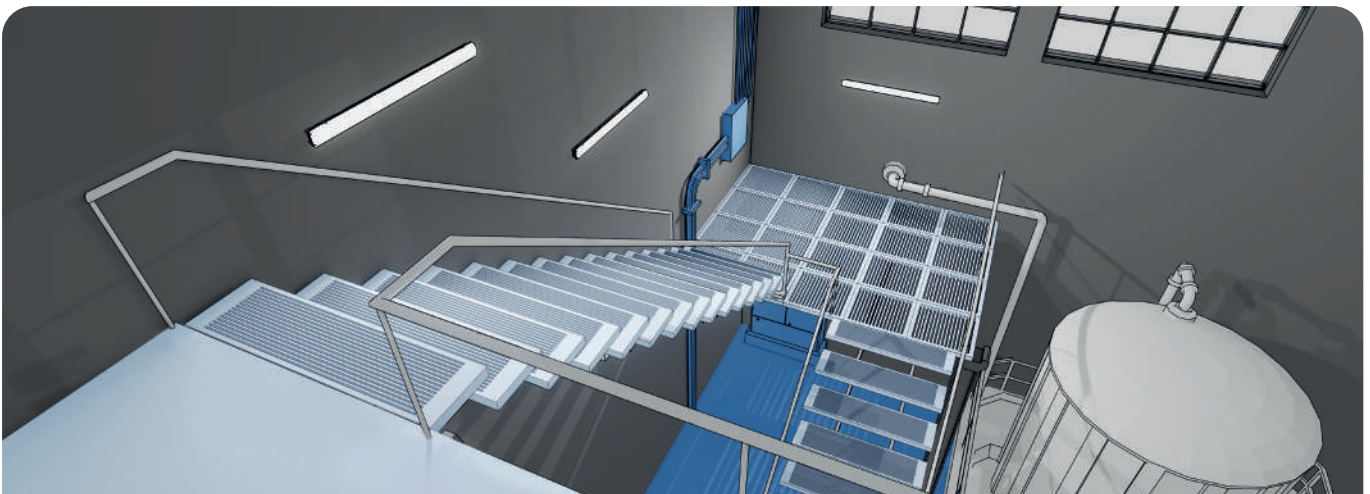

Lighting is also significant in ancillary industrial areas. The right light level makes it safe and comfortable for people to walk through, so DUNA FLEX ST offers 4,100 and 6,100lm versions to suit different needs. When luminaires are within easy reach, it is important also to ensure IK08 impact resistance.

DUNA FLEX STP

LENGTH (mm)	LUMINOUS FLUX (lm)	CRI	LIGHT COLOUR (K)	DRIVER	HOUSING	DIFFUSER	CLOSING CLIPS	CONNECTION	THROUGH WIRING
1.2: 1200	40: 4000	8: >80	40: 4000	ET: non dimmable	PC: PC	DPC: PC	PA: polyamide	Grommet + terminal block	3x1.5mm ²
1.5: 1500	60: 6000	9: >90	30: 3000	ETDD: DALI dimmable	SMC: GRP	DPM: PMMA	IX-U: stainless steel unremovable	CG: cable gland + terminal block	5x2.5mm ²
	25: 2500		65: 6500	ETD: 1-10V dimmable			PA-U: polyamide unremovable IX: stainless steel	TWW: Wieland fast connector TWS: Stucchi fast connector	

More options available: · Emergency kit: 1 hour (EB1), 3 hours (EB3) or 3 hours DALI (EB3 DALI)

DUNA FLEX ST

LENGTH (mm)	LUMINOUS FLUX (lm)	CRI	LIGHT COLOUR (K)	DRIVER	HOUSING	DIFFUSER	CLOSING CLIPS	CONNECTION	THROUGH WIRING
1.2: 1200	40: 4100	8: >80	40: 4000	ET: non dimmable	PC: PC	DPC: PC	PA-U: polyamide unremovable	Grommet + terminal block	3x1.5mm ²
1.5: 1500	60: 6100						IX: stainless steel IX-U: stainless steel unremovable PA: polyamide	CG: cable gland + terminal block	3x2.5mm ²
								TWW: Wieland fast connector TWS: Stucchi fast connector	



Operational data

DUNA FLEX STP

Description	Reference	Luminous flux (lm)	Power (W)	Efficiency (lm/W)	Temperature range
DSTP 1.2 40-840 ET PC DPC IX-U	10203613	4000	28	145	-25°C - +40°C
DSTP 1.2 40-840 ET PC DPC PA	10171079	4000	30	130	-25°C - +40°C
DSTP 1.2 40-840 ETDD PC DPC IX-U	10203614	4000	28	145	-25°C - +40°C
DSTP 1.2 40-840 ET PC DPC IX-U 3x1.5	10203615	4000	28	145	-25°C - +35°C
DSTP 1.2 40-840 ET PC DPC PA 3x1.5	10171081	4000	30	130	-25°C - +35°C
DSTP 1.2 40-840 ETDD PC DPC IX-U 5x2.5	10203616	4000	28	145	-25°C - +35°C
DSTP 1.5 60-840 ET PC DPC PA	10171080	6000	46	130	-25°C - +40°C
DSTP 1.5 60-840 ET PC DPC IX-U	10203630	6000	42	145	-25°C - +40°C
DSTP 1.5 60-840 ETDD PC DPC IX-U	10203631	6000	42	145	-25°C - +40°C
DSTP 1.5 60-840 ET PC DPC IX-U 3x1.5	10203632	6000	42	145	-25°C - +35°C
DSTP 1.5 60-840 ET PC DPC PA 3x1.5	10171082	6000	46	130	-25°C - +35°C
DSTP 1.5 60-840 ETDD PC DPC IX-U 5x2.5	10203633	6000	42	145	-25°C - +35°C

DUNA FLEX ST



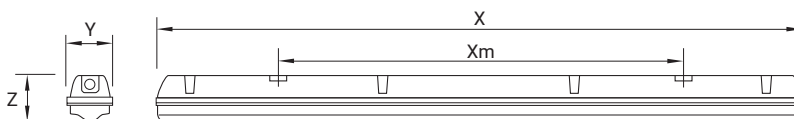

Description	Reference	Luminous flux (lm)	Power (W)	Efficiency (lm/W)	Temperature range
DST 1.2 40-840 ET PC DPC PA-U	10199112	4100	32	130	-20°C - +35°C
DST 1.2 40-840 ET PC DPC PA-U 3x1.5	10214674	4100	32	130	-20°C - +35°C
DST 1.5 60-840 ET PC DPC PA-U	10214673	6100	47	130	-20°C - +35°C
DST 1.5 60-840 ET PC DPC PA-U 3x1.5	10214675	6100	47	130	-20°C - +35°C

Dimensions and logistics

Description	X (mm)	Xm (mm)	Y (mm)	Z (mm)	L x W x H (mm)	KG Item	Pcs./Box	KG Box	Groupage Pcs./pallet	FTL/container Pcs./Double pallet
DSTP / DST 1.2...	1277	800	101	84	1384 x 104 x 84	1.7	1	1.8	119	77 + 77
DSTP / DST 1.5...	1573	1100	101	84	1646 x 104 x 84	2.2	1	2.3	119	77 + 77



Accessories

Description	Reference
 Suspension wire 2m hook and fastener, 1 unit ¹	10103049
 Theft protection (required for wall mounting), set for 1 luminaire	10149442
 ZBWM wall mounting accessory (allows luminaire rotation), 2 pieces set	10207593
 Fixing clips in stainless steel 316L, 2 units	10256809

¹ 2 units required per luminaire

DUNA BIO

Sustainability and circular economy with the use of recyclable bio-based materials with biomass origin

High efficiency
Up to 175lm/W

Housing and diffuser made of a partly bio-based polycarbonate

Optional wireless Bluetooth control for higher efficiency

Great **impact resistance**

5 YEARS
warranty



Characteristics

DUNA BIO

Mechanical

IP66 IK08

Housing	Injected partly bio-based polycarbonate (not derived from petroleum derivatives) Green RAL 6017 (Grey RAL 7035 available under request)
Diffuser	Injected partly bio-based polycarbonate, frosted finish
Closing clips	Stainless steel, unremovable
Gasket	Polyurethane
Gear tray	White lacquered steel plate
Cable entry	Cable gland
Fixing clips	Stainless steel
Suspension triangles	Stainless steel

Functional

Lifetime	L80 100,000 hours at 35°C
Fire protection	Flammability (UL94): HB
	Glow wire test (EN 60595-2-11): 850°C

Electrical



Connection	3/5 pole push wire terminal block
Power factor	>0.95 full load
THD	<10% full load
Flicker factor	<1%

Photometrical

Luminous flux	Up to 6100lm
Efficiency	Up to 175lm/W
SDCM	< 3

Polar diagram

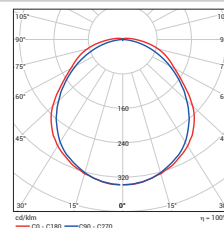

Applications



Corridor



Warehouse



Parking



Factory



Workshop



Thanks to its high performance, DUNA BIO is an excellent solution for **quality lighting**.

Its **resistance and robustness** make it suitable for industrial environments or ancillary areas, while also providing a further step in **environmental care**.

Options

Special options in grey under request

LENGTH (mm)	LUMINOUS FLUX (lm)	CRI	LIGHT COLOUR (K)	DRIVER	CLOSING CLIPS	CONNECTION	THROUGH WIRING	SENSOR
1.2: 1200 1.5: 1500	40: 4000 60: 6000 MF: multilumen 2000 to 8000	8: >80 9: >90	40: 4000 30: 3000 65: 6500 827-865: tunable white	ET: non dimmable ETD: 1-10V dimmable	IX-U: stainless steel unremovable	CG: cable gland + terminal block TWW: Wieland fast connector TWS: Stucchi fast connector	5x2.5mm ² 5x1.5mm ²	HFS FC: high frequency sensor with corridor function

Operational data

Description	Reference	Luminous flux (lm)	Power (W)	Efficiency (lm/W)	Temperature range
DBHE 1.2 42-840 ET IX-U CG	10243456	4200	25	170	-30°C - +50°C
DBHE 1.2 42-840 ET IX-U CG 5x2.5	10243459	4200	25	170	-30°C - +40°C
DBHE 1.2 42-840 ET IX-U CG HFS FC	10296020	4200	26	168	-30°C - +40°C
DBHE 1.5 61-840 ET IX-U CG	10243457	6100	35	175	-30°C - +50°C
DBHE 1.5 61-840 ET IX-U CG 5x2.5	10243458	6100	35	175	-30°C - +40°C

Dimensions and logistics

Description	X (mm)	Xm (mm)	Y (mm)	Z (mm)	L x W x H (mm)	KG Item	Pcs./Box	KG Box	Groupage Pcs./pallet	FTL/container Pcs./Double pallet
DBHE 1.2...	1277	800	101	84	1384 x 104 x 84	1.7	1	1.8	119	77 + 77
DBHE 1.5...	1573	1100	101	84	1646 x 104 x 84	2.2	1	2.3	119	77 + 77

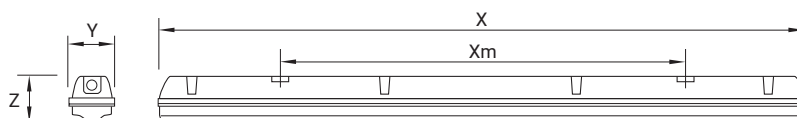

Accessories

Description	Reference	Description	Reference
Suspension wire 2m hook and fastener, 1 unit ¹	10103049	ZBWM wall mounting accessory (allows luminaire rotation), 2 pieces set	10207593
Theft protection (required for wall mounting), set for 1 luminaire	10149442	Fixing clips in stainless steel 316L, 2 units	10256809

¹ 2 units required per luminaire

Reliable for hot environments up to 55°C

Usual applications:



Logistics



Parking



Warehouse



Workshop

LUMINA

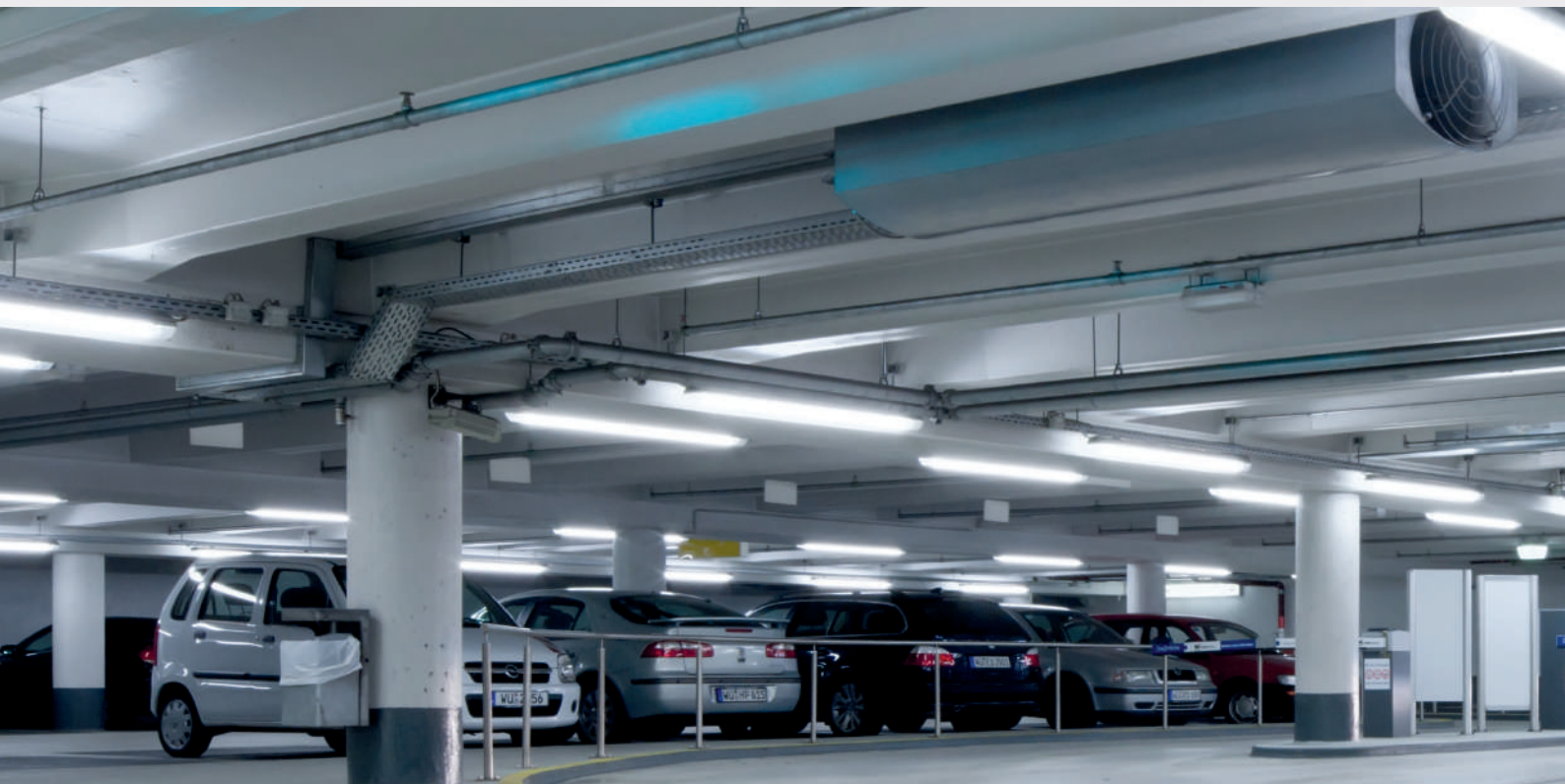

NEW



NAIREF EURLEDA G3



EURLEDA G3



Characteristics

EURLEDA G3

Mechanical

IP66 IK08

Housing	Injected polycarbonate (PC) Grey RAL 7035
Diffuser	Injected polycarbonate (PC) with UV protection Prismatic design for an optimum light distribution
Closing clips	Polyamide 6 unremovable
Gasket	Polyurethane
Grear tray	White lacquered steel plate
Cable entry	Cable gland
Fixing clips	Stainless steel

Functional

Lifetime	L70B50 50,000 hours
Fire protection	Flammability (UL94): HB
	Glow wire test (EN 60595-2-11): 850°C

Electrical



Connection	3/5 pole push wire terminal block
Power factor	>0.90
THD	<20%

Photometrical

Luminous flux	Up to 6,300lm
Efficiency	Up to 154lm/W
SDCM	< 3

Polar diagram

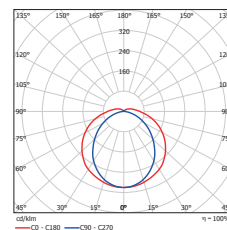

Applications

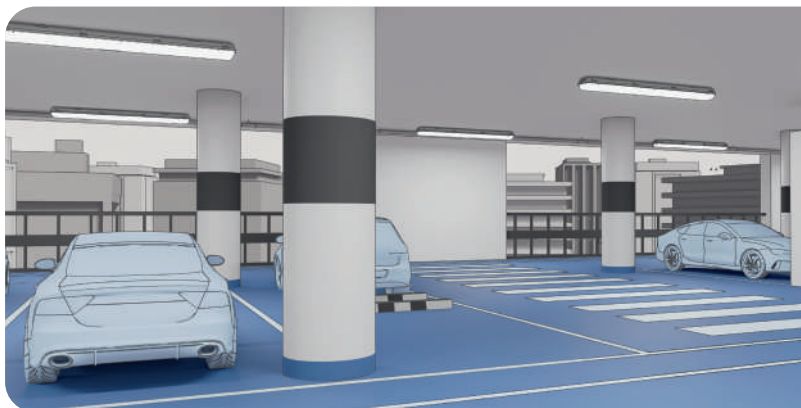

For simple spaces with high temperatures, EURLEDA G3 offers a reliable lighting solution, with a robust finish for a high impacts resistance and suitable for spaces with up to 55°C.

It allows the replacement of traditional luminaires for a high efficiency LED solution.

Options

LENGTH (mm)	LUMINOUS FLUX (lm)	CRI	LIGHT COLOUR (K)	DRIVER	HOUSING	DIFFUSER	CLOSING CLIPS	SENSOR	EMERGENCY KIT
0.6: 600	20: 2000	8: 80	40: 4000	ET: non dimmable	PC: polycarbonate	APC: polycarbonate	PAU-U: polyamide unremovable	HFS: high frequency sensor	EB3: 3 hours
1.2: 1200	40: 4000		65: 6500	ETDD: DALI dimmable					
1.5: 1500	63: 6300								

Operational data

Description	Reference	Luminous flux (lm)	Power (W)	Efficiency (lm/W)	Luminous flux emergency	Temperature range
EURLEDA G3 0.6 20-840 ET PC APC PA-U	10306936	2000	15	133	-	-20°C - +55°C
EURLEDA G3 0.6 20-840 ETDD PC APC PA-U	10306937	2000	15	133	-	-20°C - +55°C
EURLEDA G3 0.6 20-865 ET PC APC PA-U	10330309	2000	15	133	-	-20°C - +55°C
EURLEDA G3 0.6 20-865 ETDD PC APC PA-U	10330310	2000	15	133	-	-20°C - +55°C
EURLEDA G3 0.6 20-840 ET SMC APC PA-U	10363529	2000	15	133	-	-20°C - +55°C
EURLEDA G3 1.2 40-840 ET PC APC PA-U	10306938	4000	27	148	-	-20°C - +55°C
EURLEDA G3 1.2 40-840 ETDD PC APC PA-U	10306939	4000	27	148	-	-20°C - +55°C
EURLEDA G3 1.2 40-865 ET PC APC PA-U	10330311	4000	27	148	-	-20°C - +55°C
EURLEDA G3 1.2 40-865 ETDD PC APC PA-U	10330312	4000	27	148	-	-20°C - +55°C
EURLEDA G3 1.2 40-840 ET SMC APC PA-U	10363530	4000	27	148	-	-20°C - +55°C
EURLEDA G3 1.5 63-840 ET PC APC PA-U	10306940	6300	41	154	-	-20°C - +55°C
EURLEDA G3 1.5 63-840 ETDD PC APC PA-U	10306941	6300	41	154	-	-20°C - +55°C
EURLEDA G3 1.5 63-865 ET PC APC PA-U	10330313	6300	41	148	-	-20°C - +55°C
EURLEDA G3 1.5 63-865 ETDD PC APC PA-U	10330314	6300	41	148	-	-20°C - +55°C
EURLEDA G3 1.5 63-840 ET SMC APC PA-U	10363531	6300	41	148	-	-20°C - +55°C
HIGH FREQUENCY SENSOR						
EURLEDA G3 0.6 20-840 ET PC APC PA-U HFS	10331952	2000	16	125	-	-20°C - +55°C
EURLEDA G3 0.6 20-865 ET PC APC PA-U HFS	10331953	2000	16	125	-	-20°C - +55°C
EURLEDA G3 1.2 40-840 ET PC APC PA-U HFS	10331954	4000	28	143	-	-20°C - +55°C
EURLEDA G3 1.2 40-865 ET PC APC PA-U HFS	10331955	4000	28	143	-	-20°C - +55°C
EURLEDA G3 1.5 63-840 ET PC APC PA-U HFS	10331956	6300	42	150	-	-20°C - +55°C
EURLEDA G3 1.5 63-865 ET PC APC PA-U HFS	10331957	6300	42	150	-	-20°C - +55°C
EMERGENCY KIT						
EURLEDA G3 0.6 20-840 ET PC APC PA-U EB3	10331405	2000	18	111	200	0°C +30°C
EURLEDA G3 0.6 20-865 ET PC APC PA-U EB3	10331406	2000	18	111	350	0°C +30°C
EURLEDA G3 0.6 20-840 ET SMC APC PA-U EB3	10363532	2000	18	111	350	0°C +30°C
EURLEDA G3 1.2 40-840 ET PC APC PA-U EB3	10331407	4000	32	125	470	0°C +30°C
EURLEDA G3 1.2 40-865 ET PC APC PA-U EB3	10331408	4000	32	125	470	0°C +30°C
EURLEDA G3 1.2 40-840 ET SMC APC PA-U EB3	10363533	4000	32	125	470	0°C +30°C
EURLEDA G3 1.5 63-840 ET PC APC PA-U EB3	10331409	6300	44	143	650	0°C +30°C
EURLEDA G3 1.5 63-865 ET PC APC PA-U EB3	10331410	6300	44	143	650	0°C +30°C
EURLEDA G3 1.5 63-840 ET SMC APC PA-U EB3	10363534	6300	44	143	650	0°C +30°C

Dimensions and logistics

Description	X	Xm	Y	Z						
	mm	mm	mm	mm	L x W x H mm	Item	Pcs./Box	Box	Groupage Pcs./pallet	FTL/container Pcs./Double pallet
EURLEDA G3 0.6...	665	390	145	101	660 x 149 x 103	1.3	1	2.0	266	294
EURLEDA G3 1.2...	1282	800	145	101	1282 x 149 x 103	2.2	1	3.3	133	147
EURLEDA G3 1.5...	1578	1100	145	101	1579 x 149 x 103	2.7	1	4.0	133	147

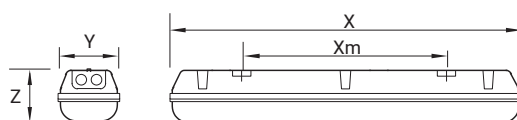

High robustness and resistance against corrosion,
ammonia and salty environments

Usual applications:

STRONGERTUBE G2



Farm



Car wash



Chemical

STRONGERTUBE G2ZB



S pool



High moisture



Maritime

LUMIN





STRONGERTUBE



STRONGERTUBE G2

Robust finish, for a durable use in **outdoor**, preventing yellowing over time

STRONGERTUBE G2 ZB

With great thermal stability to resist to UV radiation, heat, water and ageing

High thickness PMMA resistant to chemicals and impacts

Easy to clean with jet cleaners

Specific potting process for a full gas tight sealing

For hyper chlorinated environments and outdoor

5 YEARS warranty



RoHS REACH

5 YEARS warranty



Characteristics

	STRONGERTUBE G2	STRONGERTUBE G2 ZB
--	-----------------	--------------------

Mechanical

IP66 / IP69(80°) IK08

IP66 / IP69(80°) IK10

Profile	PMMA	
End caps	Acrylonitrile styrene acrylate (ASA)	
Gasket	Polyurethane	
Gear tray	White lacquered steel plate	
Cable entry	Cable gland 3m external cable connected to the luminaire, with resistant outer sheat	
Fixing clips	Stainless steel	Special V4A 316 stainless steel fixing brackets, which allow luminaire rotation

Functional

Lifetime	L80 100,000 hours at 35°C	
Fire protection	Flammability (UL94):	HB
	Glow wire test (EN 60595-2-11):	650°C

Electrical



Connection	3/5 pole push wire terminal block
Power factor	>0.95 full load
THD	<10% full load < 7% full load for HT versions
Flicker factor	<1%

Photometrical

Luminous flux	Up to 12,000lm
Efficiency	150lm/W
SDCM	< 3

Polar diagram

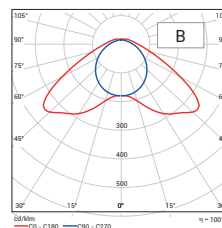

Applications

STRONGERTUBE G2



Farm



Car wash



Chemical



High moisture



Tyres storage



Long-lasting lighting solutions with **high chemical resistance** provide peace of mind to farmers. STRONGERTUBE G2 has a specific **gas tight potting** to avoid the ingress and condensation of gases and corrosive chemicals, and resists to acids and sulphur vapours.

All guaranteed by its robust IP69K and IK10 PMMA body.

STRONGERTUBE G2 ZB



S pool



Maritime



High moisture

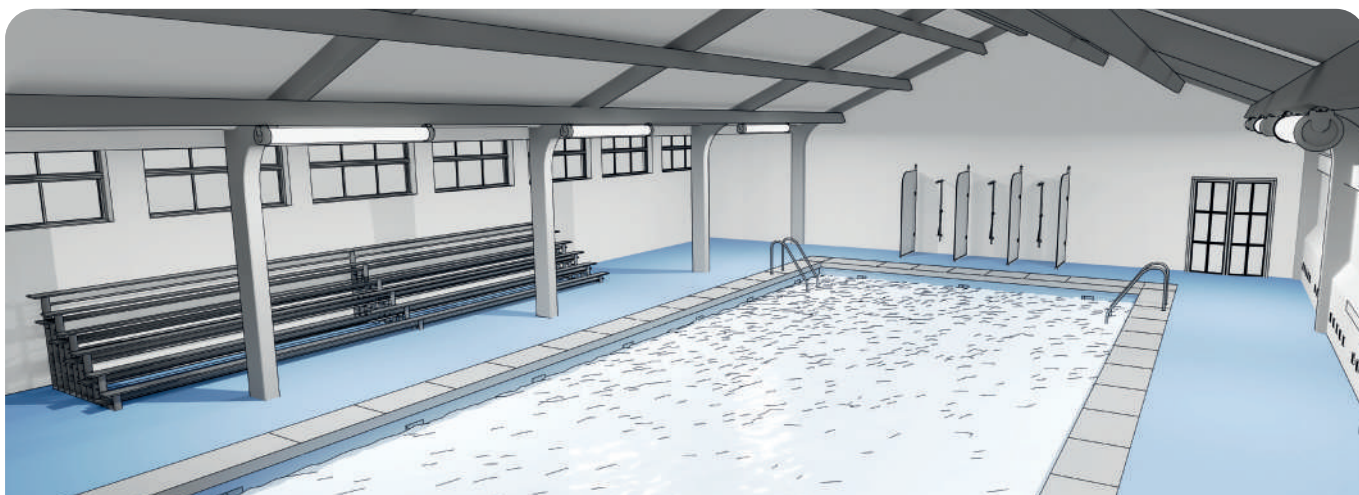

Indoor swimming pools are highly humid places, so luminaires must resist and adapt to demanding mounting. With a **316L stainless steel fixing bracket which allows rotation**, STRONGERTUBE G2 ZB is easy to install, and its ASA end caps and PMMA profile resist chlorine environments.

Maintenance becomes easier thanks to its **emergency kit with 10-years extended warranty** (on L10 versions).

STRONGERTUBE G2

OPTICS	LUMINOUS FLUX (lm)	CRI	LIGHT COLOUR (K)
B: wide	65: 6500	8: >80	40: 4000
XB: extensive	2000 to 12000		30: 3000
TB: narrow			65: 6500
			827-865: tunable white

DRIVER	TEMPERATURE RANGE	PROFILE
ET: non dimmable ETDD: DALI dimmable ETDD CS: Casambi dimmable ETD: 1-10V dimmable ETDD CLO: Constant Lumen Output	HT: up to +50°C	PMMA

More options available:

- High frequency sensor (HFS)
- Through wiring: 3x1.5mm², 3x2.5mm², 5x1.5mm², 5x2.5mm²
- Length: 1800mm with 10,000lm
- Emergency kit (luminaire version without sealed end caps)

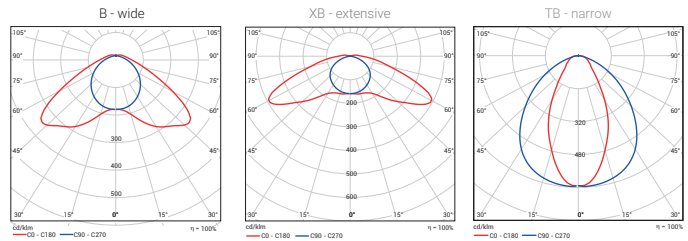

Its gas tight specific potting process avoids the ingress and condensation of gases.

IP69K protected: appropriate for jet cleaners with water up to 80°C and 100 bar pressure.

STRONGERTUBE G2 ZB

EMERGENCY KIT	OPTICS	LUMINOUS FLUX (lm)	CRI	LIGHT COLOUR (K)	DRIVER	TEMPERATURE RANGE	PROFILE	FIXING CLIPS
L10: emergency kit 1 hour autonomy with 10 years extended guarantee	B: wide XB: extensive TB: narrow	65: 6500 2000 to 8000	8: >80	40: 4000 30: 3000 65: 6500 827-865: tunable white	ET: non dimmable ETDD: DALI dimmable ETDD CS: Casambi dimmable ETD: 1-10V dimmable ETDD CLO: Constant Lumen Output	HT: up to +50°C	PMMA	ZB: special stainless steel fixing brackets

More options available:

- High frequency sensor (HFS)
- Through wiring: 3x1.5mm², 3x2.5mm², 5x1.5mm², 5x2.5mm²
- Length: 1800mm with 10,000lm

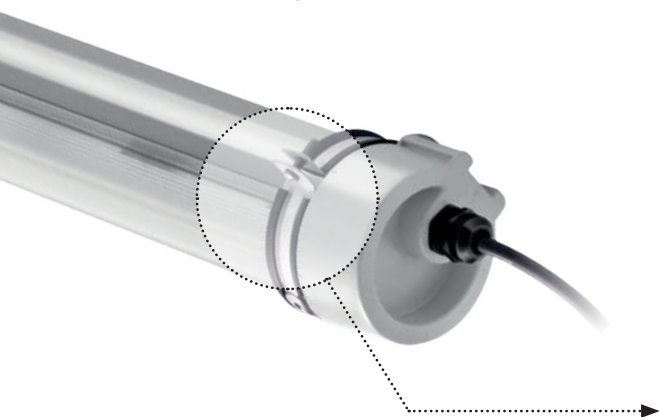
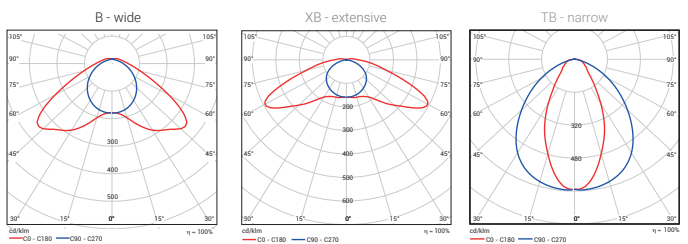



Special V4A 316 stainless steel fixing brackets for STRONGERTUBE ZB, 2 pieces set (included in STRONGERTUBE G2 ZB standard references) (Reference: 10185019)

Operational data

STRONGERTUBE G2

Description	Reference	Luminous flux (lm)	Power (W)	Efficiency (lm/W)	Temperature range
STRONGERTUBE G2 B 6500-840 ET PMMA	10231696	6500	43	150	-25°C - +45°C
STRONGERTUBE G2 B 6500-840 ETDD PMMA	10231697	6500	43	150	-25°C - +45°C
 HIGH TEMPERATURE					
STRONGERTUBE G2 B 6500-840 ET HT PMMA	10175731	6500	43	150	-40°C - +50°C
STRONGERTUBE G2 B 6500-840 ETDD HT PMMA	10175732	6500	43	150	-40°C - +50°C

STRONGERTUBE G2 ZB

Description	Reference	Luminous flux (lm)	Power (W)	Efficiency (lm/W)	Temperature range
STRONGERTUBE G2 B 6500-840 ET PMMA ZB	10223683	6500	43	150	-25°C - +45°C
STRONGERTUBE G2 B 6500-840 ETDD PMMA ZB	10223685	6500	43	150	-25°C - +45°C
 HIGH TEMPERATURE					
STRONGERTUBE G2 B 6500-840 ET HT PMMA ZB	10223684	6500	43	150	-40°C - +50°C
STRONGERTUBE G2 B 6500-840 ETDD HT PMMA ZB	10223686	6500	43	150	-40°C - +50°C
 EMERGENCY KIT WITH 10-YEARS EXTENDED GUARANTEE¹					
STRONGERTUBE G2 L10 B 6500-840 ET PMMA ZB	10254109	6500	43	150	0°C - +40°C
STRONGERTUBE G2 L10 B 6500-840 ETDD PMMA ZB	10253420	6500	43	150	0°C - +40°C

¹ Only in emergency kit (luminaire warranty: 5 years). Standard emergency kit guarantee available under request (luminaire version without sealed end caps)

Dimensions and logistics

Description	X (mm)	Xm (mm)	Y (mm)	Z (mm)	L x W x H (mm)	KG Item	Pcs./Box	KG Box	Groupage Pcs./pallet	FTL/container Pcs./Double pallet
STRONGERTUBE G2 ...	1340	1205	112	112	1345 x 113 x 126	4.6	1	4.8	54	42 + 42

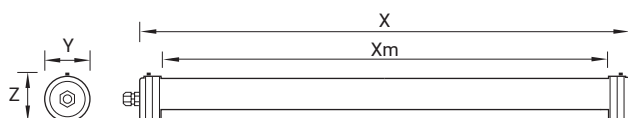

Accessories

Description	Reference
 Fixing clips STRONGERTUBE stainless steel 316L	10251746

Robust luminaire with high protection for indoor and outdoor applications

Usual applications:



Storage



Logistics



Parking



Factory

LUMINA





NAIPRE ZALEDA



ZALEDA EVOL G2

Safe for outdoor in areas without a roof

Theft protection included

Plug & play weatherproof connector for tool-less, fast and easy installation

Wide temperature range, from cold storages to heavy industries

Excellent thermal management

5 YEARS warranty



Characteristics

ZALEDA EVOL G2

Mechanical

PC: **IK08** IP66 PMMA: **IK03**

Housing	Die-cast aluminium alloy EN-47100 Grey RAL DB703	
Diffuser	Injected polycarbonate with UV protection, opal finish	Injected PMMA with UV protection, opal finish
Gasket	Polyurethane	
Gear tray	White lacquered steel plate	
Fixing clips	Stainless steel	
Suspension triangles	Stainless steel	
Theft protection	Stainless steel (included)	

Functional

Lifetime	L80B50 85,000 hours at 35°C		
Fire protection	Flammability (UL94):	V2	HB
	Glow wire test (EN 60595-2-11):	850°C	650°C

Electrical



Connection	3 pole weatherproof fast connector
Power factor	>0.95 full load
THD	<10% full load
Flicker factor	<1%

Photometrical

Luminous flux	Up to 6,200lm
Efficiency	Up to 167lm/W
SDCM	< 3

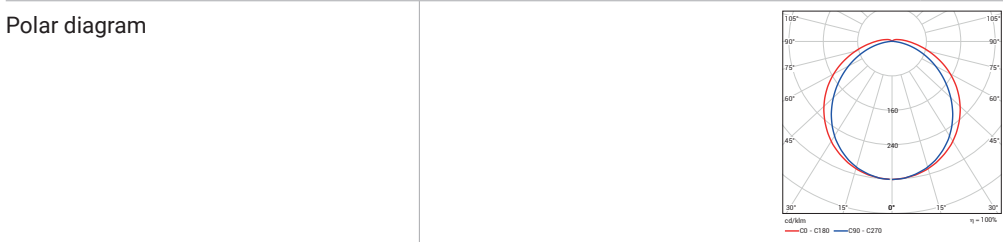

Applications



Storage



Logistics



Parking



Factory



Warehouse



High moisture



High performance in cold storages is possible, thanks to the excellent thermal management in ZALEDA and its **wide temperature range**.

PMMA or PC diffuser is available to adapt to different needs, while its **WAGO fast connector** speeds up installation.

Options

LUMINOUS FLUX (lm)	CRI	LIGHT COLOUR (K)	DRIVER	DIFFUSER	THROUGH WIRING
4000: ~4500 6000: ~6200	8: >80	40: 4000	ET: non-dimmable	PC: polycarbonate PMMA	3x1.5mm ²

More options available: · High bay versions 8,000 lm and 10,000 lm
· Overvoltage protection KV4 / 5

Operational data

Description	Reference	Luminous flux (lm)	Power (W)	Efficiency (lm/W)	Temperature range
PC DIFFUSER					
ZALEDA EVOL G2 4000-840 ET PC	10145978	4400	27	163	-30°C - +45°C
ZALEDA EVOL G2 4000-840 ET PC 3X1.5	10145982	4400	27	163	-30°C - +45°C
ZALEDA EVOL G2 6000-840 ET PC	10145979	6000	38	158	-30°C - +45°C
ZALEDA EVOL G2 6000-840 ET PC 3X1.5	10145983	6000	38	158	-30°C - +45°C
PMMA DIFFUSER					
ZALEDA EVOL G2 4000-840 ET PMMA	10145980	4500	27	167	-30°C - +45°C
ZALEDA EVOL G2 4000-840 ET PMMA 3X1.5	10145984	4500	27	167	-30°C - +45°C
ZALEDA EVOL G2 6000-840 ET PMMA	10145981	6200	38	163	-30°C - +45°C
ZALEDA EVOL G2 6000-840 ET PMMA 3X1.5	10145985	6200	38	163	-30°C - +45°C

Dimensions and logistics

Description	X (mm)	Xm (mm)	Y (mm)	Z (mm)	L x W x H (mm)	KG Item ¹	Pcs./Box	KG Box	Groupage Pcs./pallet	FTL/container Pcs./Double pallet
ZALEDA EVOL G2...	1047	492	95	105	1085 x 100 x 125	2.9	1	3.1	96	72 + 72

¹ Weight in through wiring versions: +0.1KG

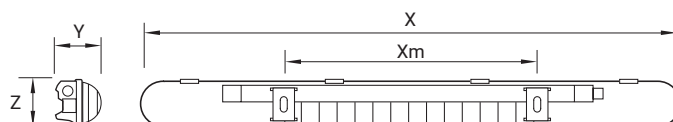

Accessories

Description	Reference
 ZBWM wall mounting accessory (allows luminaire rotation), 2 pieces set	10207593

All-round impact resistant solution, designed for LED tube

Usual applications:

ALHAMA LED-T8



Corridor



Factory



Workshop

ALHAMA T-LED



Cloakroom



Workshop



Corridor

LUMINA





VAIRE

ALHAMA



ALHAMA LED-T8

Tool-free access to the tray to facilitate installation and maintenance



Characteristics

ALHAMA LED-T8

Mechanical

IK08 IP66

Housing	Injected polycarbonate with UV protection Grey RAL 7035
Diffuser	Injected polycarbonate with UV protection
Closing clips	Polyamide 6
Gasket	Polyurethane
Gear tray	White lacquered steel plate
Cable entry	Grommet
Lamp holder	G13
Fixing clips	Stainless steel
Suspension triangles	Stainless steel

Functional



Fire protection	Flammability (UL94):	V2
	Glow wire test (EN 60595-2-11):	850°C

Electrical

Electrical protection	Starterholder for starter LED placement Suppressor filter to reduce the influence of any interference that may occur due to the power source
-----------------------	---

Photometrical

Polar diagram

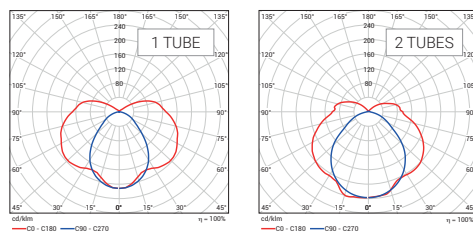

Luminaire tested for the following LED tubes: Osram ST8A-EM and Philips MasterLED-EM.
For other tubes please ensure that they are suitable for ALHAMA LED-T8.

Applications

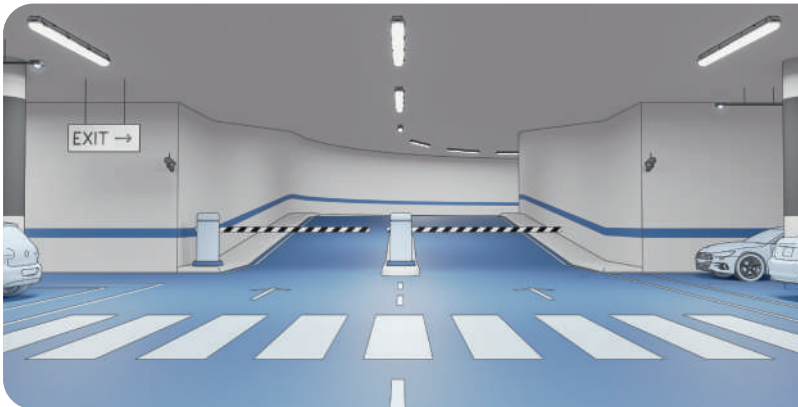

Versatility is required in industrial applications, due to the specific needs of each area. ALHAMA LED-T8 is a **highly adaptable** luminaire thanks to its six sizes.

It allows you to easily incorporate an **LED tube**, for greater control of the installation.

Options

LED TUBE TYPE	LAMP TYPE	DIFFUSER	CONFIGURATION
118: 1x600mm 136: 1x1200mm 158: 1x1500mm 218: 2x600mm 236: 2x1200mm 258: 2x1500mm	LED-T8: tube (NOT included)	PC: polycarbonate	C2: both terminals electrified

Operational data

Description	Reference	Temperature range	Connection scheme
1 TUBE			
ALHAMA 118 LED-T8 PC C2	10170601	-20°C - +35°C	
ALHAMA 136 LED-T8 PC C2	10170602	-20°C - +35°C	
ALHAMA 158 LED-T8 PC C2	10170603	-20°C - +35°C	
2 TUBES			
ALHAMA 218 LED-T8 PC C2	10170604	-20°C - +35°C	
ALHAMA 236 LED-T8 PC C2	10170605	-20°C - +35°C	
ALHAMA 258 LED-T8 PC C2	10170606	-20°C - +35°C	

Dimensions and logistics

Description	X (mm)	Xm (mm)	Y (mm)	Z (mm)	L x W x H (mm)	Pcs./Box	KG Box	Groupage Pcs./pallet	FTL/container Pcs./Double pallet
ALHAMA 118...	657	390	101	101	660 x 103 x 103	1	1.0	294	168 + 168
ALHAMA 136...	1277	800	101	101	1282 x 103 x 103	1	1.8	147	84 + 84
ALHAMA 158...	1573	1100	101	101	1579 x 103 x 103	1	2.2	147	84 + 84
ALHAMA 218...	657	390	145	101	660 x 149 x 103	1	1.3	210	120 + 120
ALHAMA 236...	1277	800	145	101	1282 x 149 x 103	1	2.2	105	60 + 60
ALHAMA 258...	1573	1100	145	101	1579 x 149 x 103	1	2.7	105	60 + 60

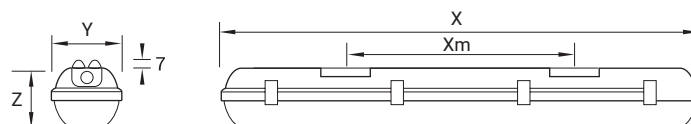

ALHAMA T-LED

Available in three lengths adaptable to all installations



Characteristics

ALHAMA T-LED

Mechanical

IK08 IP66

Housing	Injected polycarbonate with UV protection Grey RAL 7035
Diffuser	Injected polycarbonate with UV protection
Closing clips	Polyamide 6
Gasket	Polyurethane
Gear tray	White lacquered steel plate
Cable entry	Grommet
Lamp holder	G13
Fixing clips	Stainless steel
Suspension triangles	Stainless steel

Functional



Lifetime	L70 50,000 hours
Fire protection	Flammability (UL94): V2
	Glow wire test (EN 60595-2-11): 850°C

Electrical

Connection	3 pole push wire terminal block
THD	<25%
Flicker factor	<1%
Electrical protection	LED starter and filter capacitor included for overvoltage protection

Photometrical

Luminous flux	Up to 7,300lm
Efficiency	Up to 160lm/W
SDCM	< 6

Polar diagram

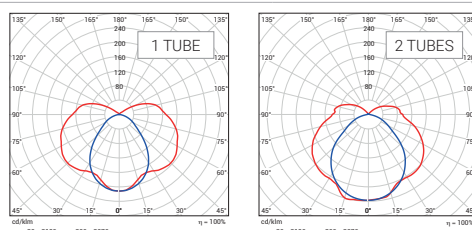

Applications



An all-round lighting solution can offer changing rooms up to 160lm/W with the simplicity and easy maintenance of LED tubes.

ALHAMA T-LED is adaptable to all installations with its **three lengths**: 600, 1,200 and 1,500mm.

Options Special options in grey under request

LUMINOUS FLUX (lm)	LAMP TYPE	DIFFUSER	CONFIGURATION	LIGHT COLOUR
118: 950 136: 2375 158: 3850 218: 1950 236: 4650 258: 7300	LED-T8: tube (included)	PC: polycarbonate PM: PMMA	C2: both terminals electrified	LM840: 4000K CRI80

Operational data

Description	Reference	Luminous flux (lm)	Power (W)	Efficiency (lm/W)	Temperature range
1 TUBE					
ALHAMA 118 LED-T8 PC C2 LM840	10194239	950	6.5	146	-20°C - +35°C
ALHAMA 136 LED-T8 PC C2 LM840	10194240	2375	15	158	-20°C - +35°C
ALHAMA 158 LED-T8 PC C2 LM840	10194241	3850	24	160	-20°C - +35°C
2 TUBES					
ALHAMA 218 LED-T8 PC C2 LM840	10194242	1950	13	150	-20°C - +35°C
ALHAMA 236 LED-T8 PC C2 LM840	10194243	4650	30	155	-20°C - +35°C
ALHAMA 258 LED-T8 PC C2 LM840	10194244	7300	48	152	-20°C - +35°C

Dimensions and logistics

Description	X (mm)	Xm (mm)	Y (mm)	Z (mm)	L x W x H (mm)	Pcs./Box	KG Box	Groupage Pcs./pallet	FTL/container Pcs./Double pallet
ALHAMA 118...	657	390	101	101	660 x 103 x 103	1	1.0	294	168 + 168
ALHAMA 136...	1277	800	101	101	1282 x 103 x 103	1	1.8	147	84 + 84
ALHAMA 158...	1573	1100	101	101	1579 x 103 x 103	1	2.2	147	84 + 84
ALHAMA 218...	657	390	145	101	660 x 149 x 103	1	1.3	210	120 + 120
ALHAMA 236...	1277	800	145	101	1282 x 149 x 103	1	2.2	105	60 + 60
ALHAMA 258...	1573	1100	145	101	1579 x 149 x 103	1	2.7	105	60 + 60

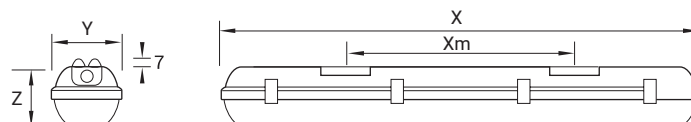

Versatile luminaire with a high quality LED tube for different applications

Usual applications:

PEP T-LED



PEM T-LED



LUMIN





NAIRE

PE



PE

PEP T-LED

PEM T-LED

Available in **three lengths**

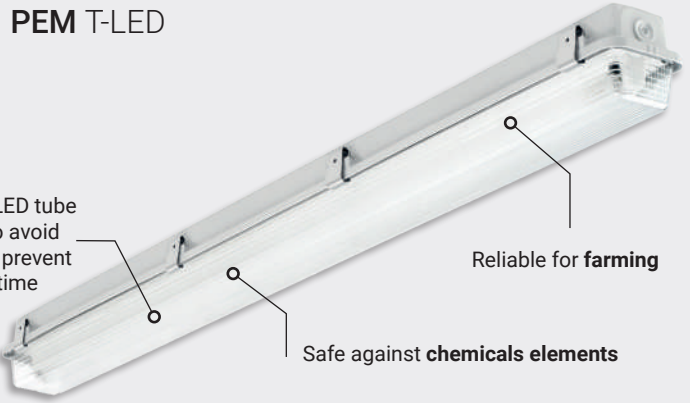
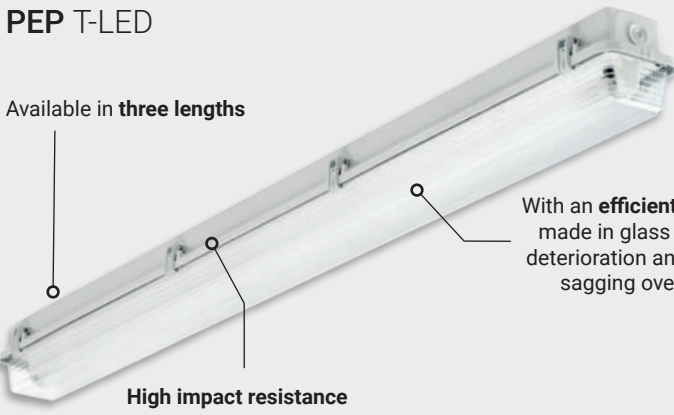

5 YEARS warranty

+35°C
-20°C

CE RoHS REACH

2 YEARS warranty

+35°C
-20°C

Characteristics

	PEP T-LED	PEM T-LED
Mechanical	IK07 IP65	IK03 IP65
Housing	Compressed fibreglass reinforced polyester (GRP) Grey RAL 7035	
Diffuser	Injected polycarbonate with UV protection	Injected PMMA with UV protection
Closing clips	Polyamide 6	Stainless steel
Gasket	Polyurethane	
Gear tray	White lacquered steel plate	
Cable entry	Grommet	Cable gland
Lamp holder	G13	
Fixing clips	Stainless steel	
Suspension triangles	Stainless steel	

Functional

Lifetime	L70 50,000 hours	
Fire protection	Flammability (UL94):	GRP: HB PC: V2
	Glow wire test (EN 60595-2-11):	GRP: 650°C PC: 850°C
		HB 650°C

Electrical



Connection	3 pole push wire terminal block	
THD	<25%	
Flicker factor	<8%	
Electrical protection	LED starter and filter capacitor included to protect against surge	

Photometrical

Luminous flux	Up to 7,200lm	Up to 7,300lm
Efficiency	Up to 158lm/W	
SDCM	< 6	

Polar diagram

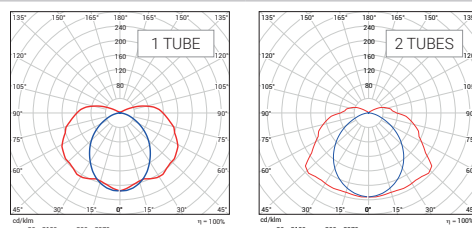

Applications

PEP T-LED



Versatile areas where workers perform different tasks require adaptable luminaires. With six different sizes, a robust impact resistant housing and a high efficiency LED tube, PEP T-LED offers high performance in an iconic luminaire design.

PEM T-LED

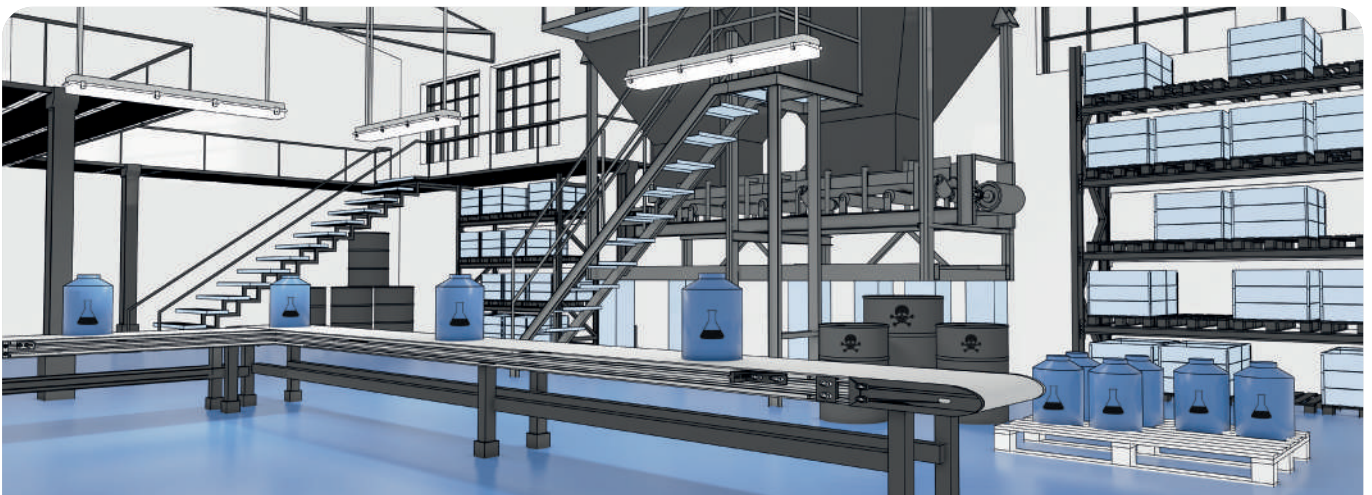

In chemical industries, there are elements which can damage the luminaires. PEM T-LED is a safe solution **manufactured in PMMA and GRP, protected against chemical elements.** It includes a high efficiency LED tube made in glass, to avoid deterioration and prevent sagging over time.

Options

PEP T-LED

LUMINOUS FLUX (lm)	LAMP TYPE	CONFIGURATION	CLOSING CLIPS	LIGHT COLOUR
118: 950 136: 2350 158: 3800 218: 1900 236: 4600 258: 7200	LED-T8: tube (included)	C2: both terminals electrified	PA: polyamide 6	LM840: 4000K CRI80



PEM T-LED

LUMINOUS FLUX (lm)	LAMP TYPE	CONFIGURATION	CONNECTION	CLOSING CLIPS	LIGHT COLOUR
118: 950 136: 2350 158: 3800 218: 1950 236: 4640 258: 7300	LED-T8: tube (included)	C2: both terminals electrified	CG: cable gland	IX: stainless steel	LM840: 4000K CRI80





Operational data





PEP T-LED

Description	Reference	Luminous flux (lm)	Power (W)	Efficiency (lm/W)	Temperature range
 1 TUBE					
PEP 118 LED-T8 C2 PA LM840	10194245	950	6.5	146	-20°C - +35°C
PEP 136 LED-T8 C2 PA LM840	10194246	2350	15	157	-20°C - +35°C
PEP 158 LED-T8 C2 PA LM840	10194247	3800	24	158	-20°C - +35°C
 2 TUBES					
PEP 218 LED-T8 C2 PA LM840	10194248	1900	13	146	-20°C - +35°C
PEP 236 LED-T8 C2 PA LM840	10194249	4600	30	153	-20°C - +35°C
PEP 258 LED-T8 C2 PA LM840	10194250	7200	48	150	-20°C - +35°C

PEM T-LED

Description	Reference	Luminous flux (lm)	Power (W)	Efficiency (lm/W)	Temperature range
 1 TUBE					
PEM 118 LED-T8 C2 CG IX LM840	10194496	950	6.5	146	-20°C - +35°C
PEM 136 LED-T8 C2 CG IX LM840	10194497	2350	15	157	-20°C - +35°C
PEM 158 LED-T8 C2 CG IX LM840	10194498	3800	24	158	-20°C - +35°C
 2 TUBES					
PEM 218 LED-T8 C2 CG IX LM840	10194499	1950	13	150	-20°C - +35°C
PEM 236 LED-T8 C2 CG IX LM840	10194500	4640	30	155	-20°C - +35°C
PEM 258 LED-T8 C2 CG IX LM840	10194501	7300	48	152	-20°C - +35°C

Dimensions and logistics

Description	X (mm)	Xm (mm)	Y (mm)	Z (mm)	 L x W x H (mm)	 Pcs./Box	 Box	 Groupage Pcs./pallet	 FTL/container Pcs./Double pallet
PEP / PEM 118...	666	230	100	108	690 x 102 x 110	1	1.0	210	168 + 168
PEP / PEM 136...	1275	840	100	108	1290 x 102 x 110	1	1.8	105	84 + 84
PEP / PEM 158...	1575	1140	100	108	1590 x 102 x 110	1	2.1	105	84 + 84
PEP / PEM 218...	666	230	170	108	690 x 172 x 110	1	1.4	120	120 + 120
PEP / PEM 236...	1275	840	170	108	1290 x 172 x 110	1	2.1	60	60 + 60
PEP / PEM 258...	1575	1140	170	108	1590 x 172 x 110	1	2.6	60	60 + 60

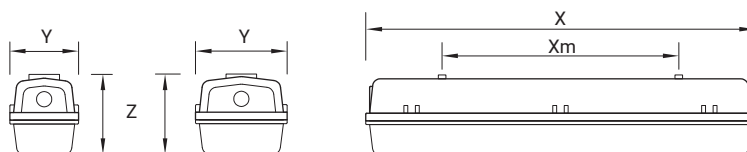

Connected lighting for industrial areas

ZALUX luminaires can incorporate wireless lighting control for improved facility management and energy savings.

ADVANCED WIRELESS LIGHTING CONTROL SYSTEM



- Connected
- Flexible
- Safe
- Easy to use
- Profitable



What are the benefits?

- **Reduce energy consumption** and contribute to environment sustainability.
- **Save installation costs** with a simpler, more flexible and faster commissioning.
- **Increase profitability** in refurbishment as there is no need to rewire to add new dimmable luminaires and sensors (only 3 wires are required).
- **Reduce maintenance costs** by optimizing luminaires lifetime and anticipating maintenance works.
- Knowing the real use and conditions of spaces to **make better decisions**.



How does it work?

Wireless connection between luminaires through Low Energy Bluetooth 

Mesh connection

- All devices connected.
- Always communicated in all directions.
- Fully interconnected and flexible.
- Every device is a signal amplifier.

High protected system

- Encrypted data.
- Inhibitor and hackers proof.

Central controller, wiring or devices out of the luminaire are not needed

Free App for mobile devices

- Monitor and access data remotely.



Check compatible models in the product catalogue or in the datasheets available at www.zalux.com.



What can you do with our wireless control system?

Dimming

Adapt the luminous flux of the luminaire to the needs of space and people.

Scenes control

Define and choose the most efficient lighting configuration at all times.

Management and monitoring

Obtain data to optimize the installation.

Presence and daylight sensor

Wireless control can be connected to sensors, which are able to activate scenes or single luminaires.

- Optimize the lighting configuration around the clock to get **up to 45% savings** during business hours.
- Daylight sensor take advantage of the natural light to provide the needed lighting level with **up to 60% savings**.

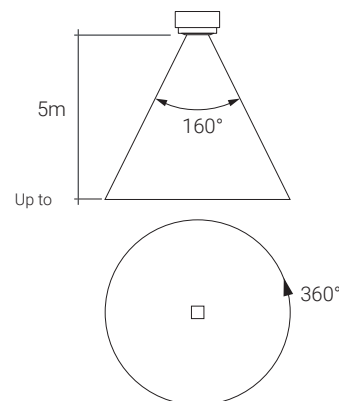

Adjustable functions

Sensitivity	Continuously between 20 and 100%
Time setting	30 sec. - 30 min.
Brightness setting	2-2,000 lux
Hold time	Continuously between 10 and 300s (2s test mode)

Bluetooth device features

Maximum range (open field)	50 m
Maximum range (indoor)	30 m
Operating radio frequencies	2,4 ... 2,483 Ghz
Maximum radio output power	+4 dBm

Product	Wireless control system
 NEZA	✓
 KE	✓
 ZALUX BASE HE	✓
 DUNA FLEX HE+	✓
 DUNA BIO	✓
 STRONGERTUBE G2	✓

Case study

Illuminating smart car park with KE

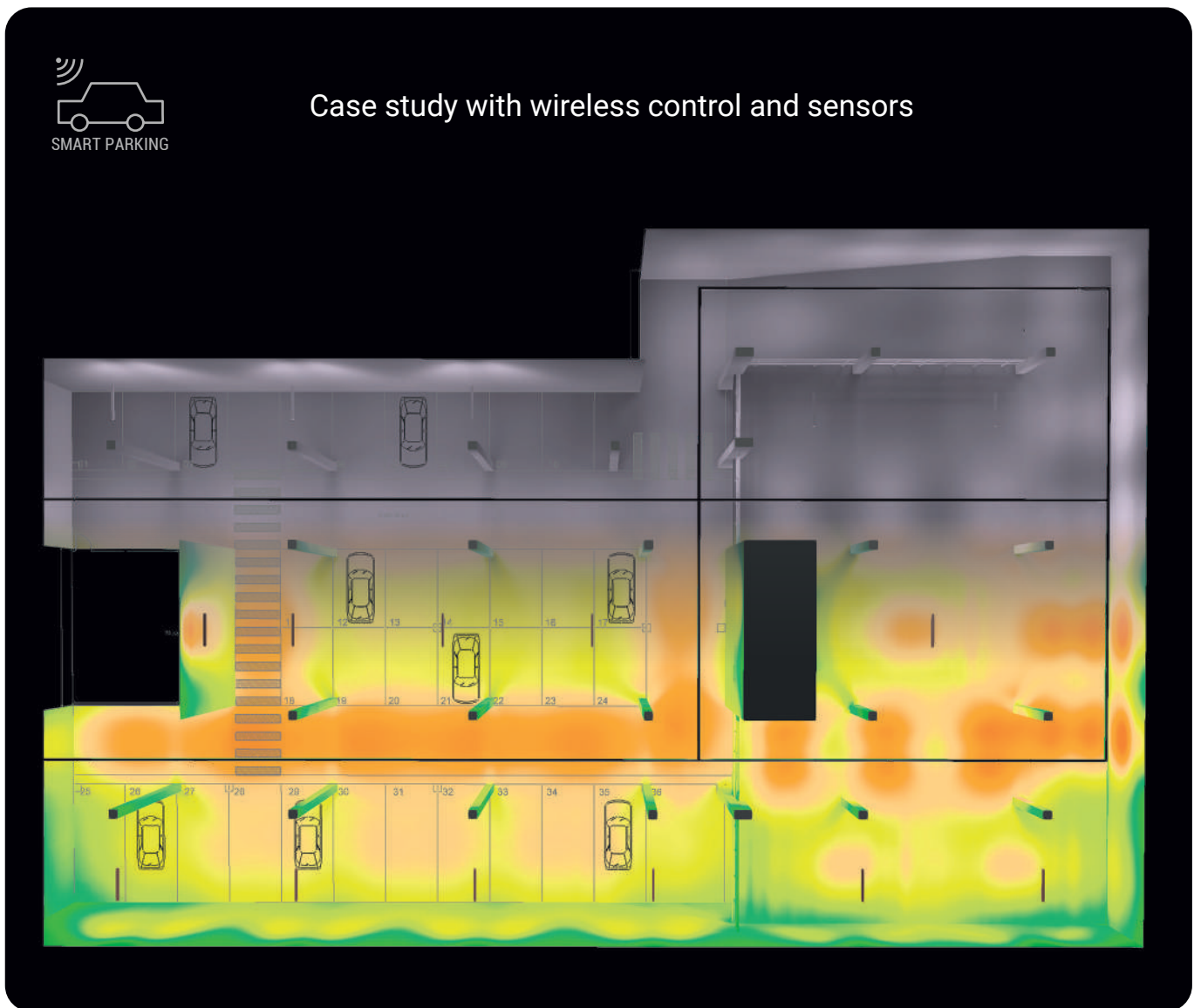

Introduction

- Car parks need to guarantee safety and optimal visual conditions for pedestrians and cars at the right time.
- These areas have an intensive activity, so detecting their real use helps to make better use of light while saving energy.

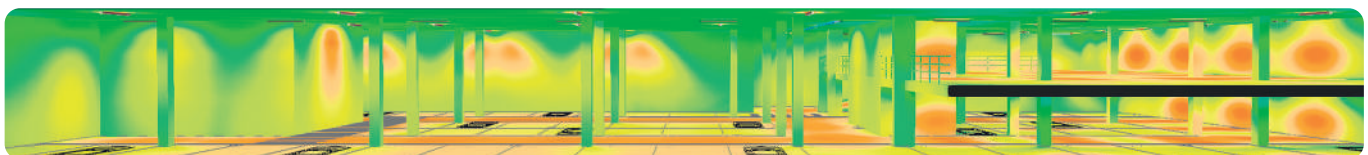

Challenges

1. **Use 24/7:** parking areas never close or are open for many hours a day.
2. **Different use from areas and time:** car parks have from light to heavy traffic in peak hours, as well as natural light, and cars move around.
3. **Protection:** dust and gas, like car fumes, could enter the luminaires and damage their electronics. Also, luminaires that are within reach can be easily damaged.
4. **Optimal light distribution:** indoor parking are dark spaces with columns and corners.
5. **Visual comfort:** warm light can reduce visual accuracy, while cold darken the area. Light must be enough and comfortable for people and cars to move securely.
6. **Flexibility:** quick installation and easy maintenance improve installation profitability, while wireless control increases flexibility.

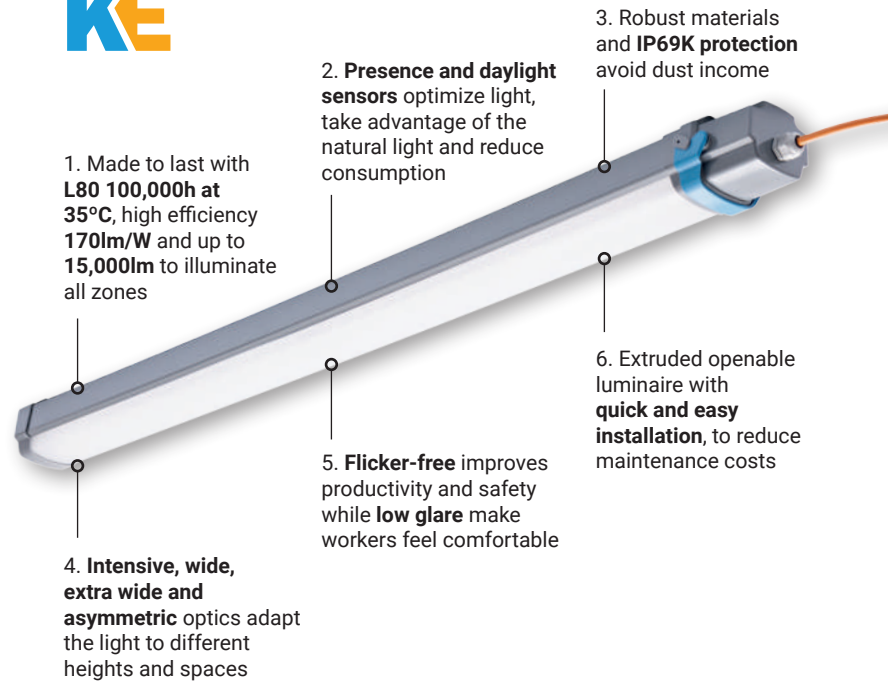

Application of KE optics

We have installed 61 KE luminaires 1500mm, with different optics depending on the area (KHE 1.5_100-840 ETDD PC HFS)

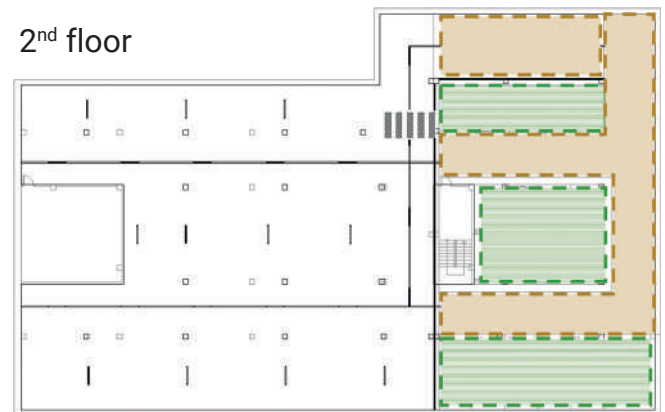
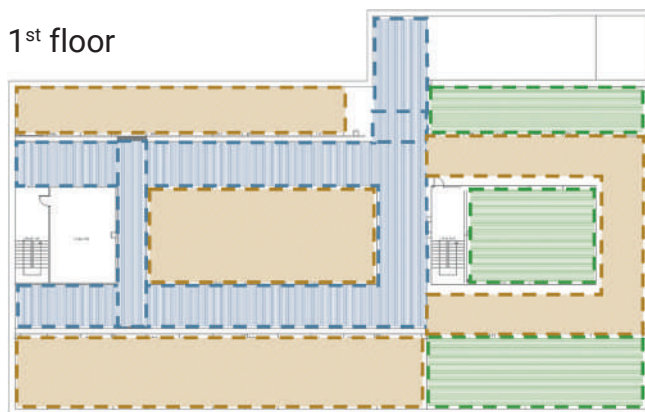

Advantages of KE optics in each area

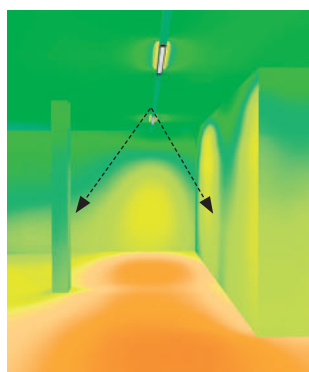
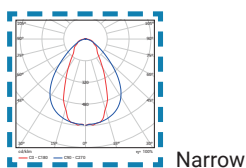

Central corridor 5.5m
 E_{med} Floor 145 lux
 Uniformity 0.62

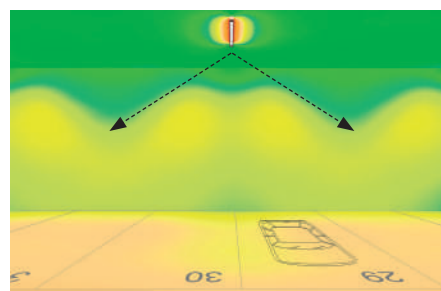
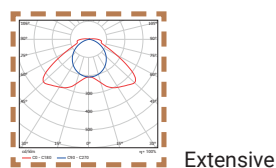

Parking spaces 5.5m
 E_{med} Floor 81 lux
 Uniformity 0.54

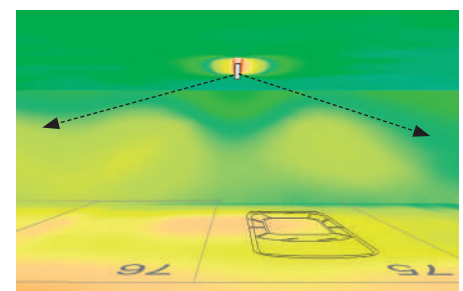
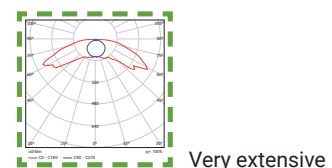

Parking spaces 2.5m
 E_{med} Floor 76 lux
 Uniformity 0.59

Achievement of lighting requirements

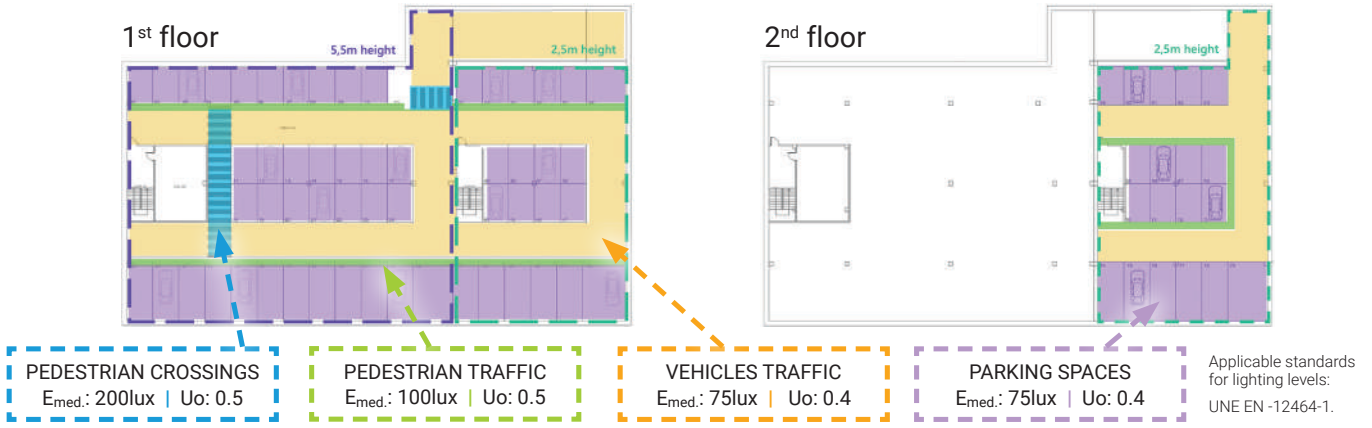

Use of presence sensors

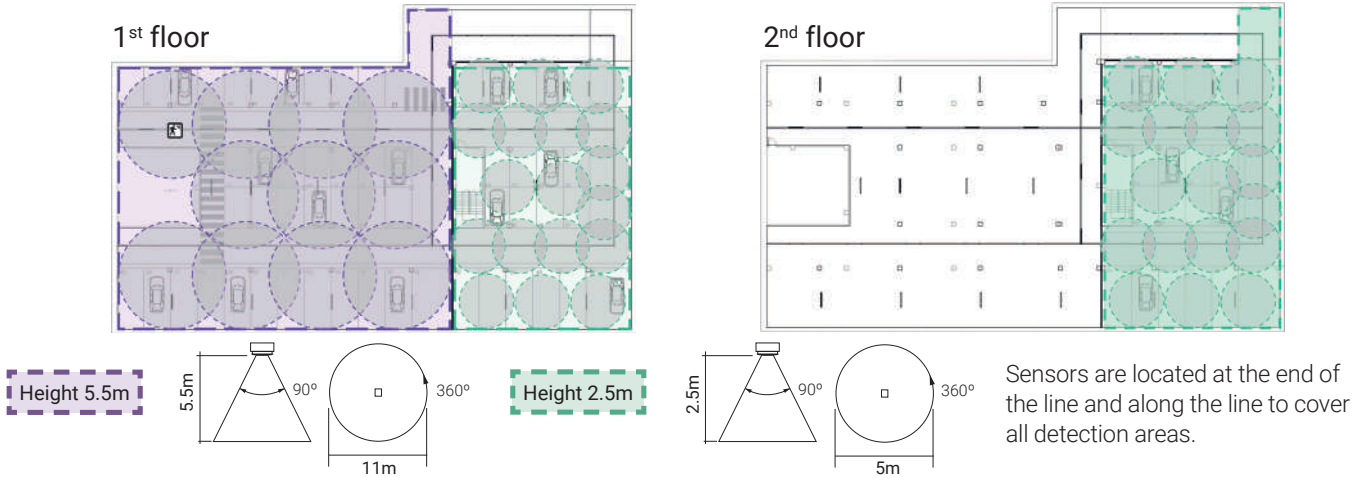

There are 2 levels of lighting:

A **minimum level** for when no presence is detected and an **optimum operating level** to ensure the correct functioning of the installation.

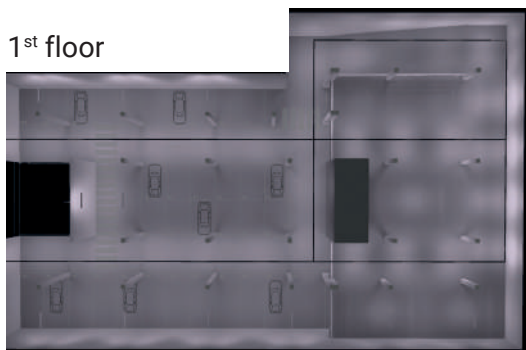
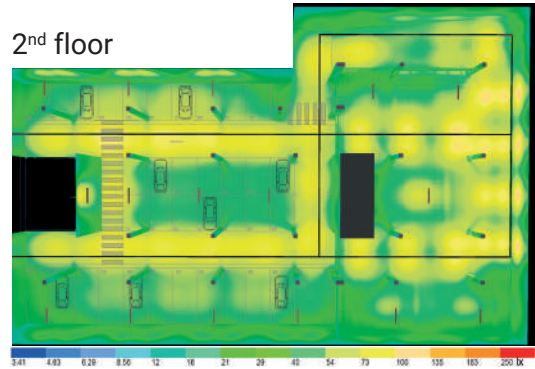
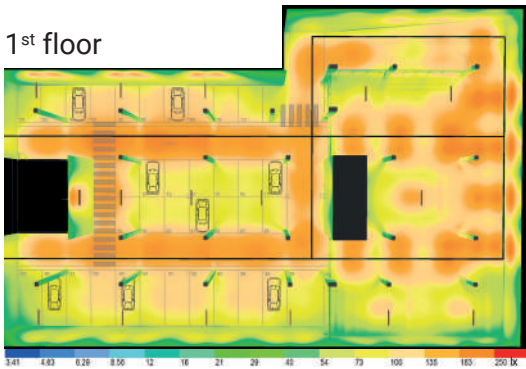

The luminaires are on at a **general illumination level** for about 12 hours a day. Sensors detect the presence of people and cars.

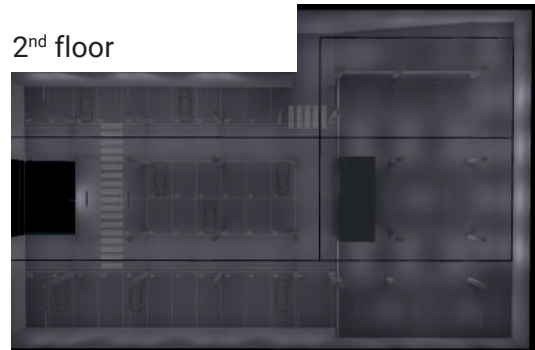

The luminaires are on at a **safe lighting level** for about 12 hours a day. There are no presence of people and cars.

KE luminaire configuration in continuous line

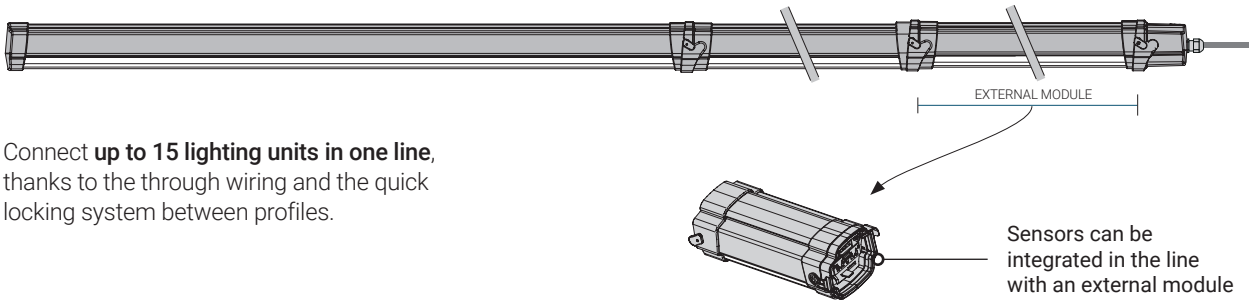

Connect **up to 15 lighting units in one line**, thanks to the through wiring and the quick locking system between profiles.

Energy savings

Study based on the installation of 61 100W KE luminaires, dimmed and in combination with presence sensors, to switch off the luminaire when 100% of the light level is not required.

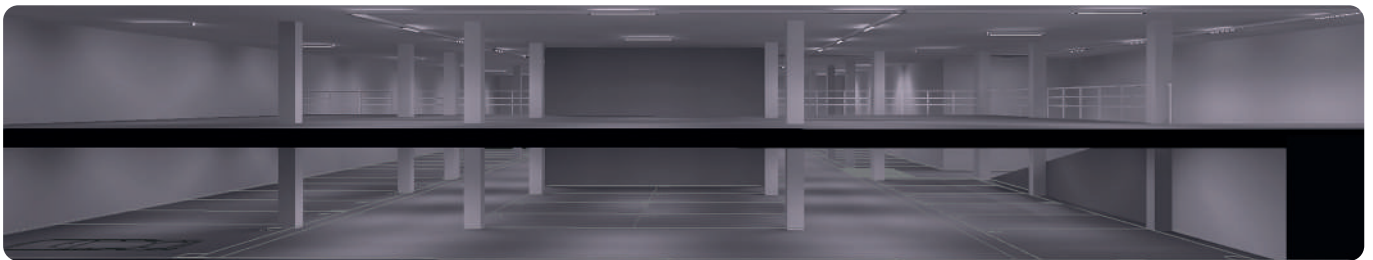

A smart car park can make good use of the light to illuminate properly, while saving energy when lighting is not needed.

Compared to traditional luminaires, dimmable LED luminaires in combination with daylight sensors can achieve **up to 80% energy savings** and reduce CO2 emissions by 34 tons per year.

Electrical figures	
Luminaires power consumption, per year	16,031 kW
Electricity cost	0.24 €/kWh
Working hours, per year	8,760 h

ROI ~1.4 years

Based on the average cost of electricity in Spain

Total cost of energy per year (€)

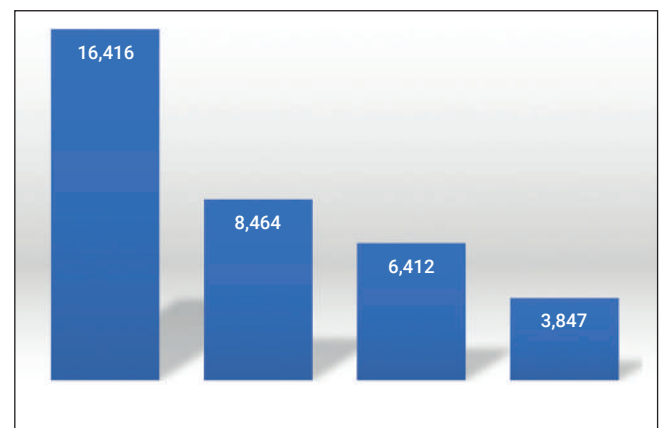

T8 weather proof luminaire 2x58W

Non dimmable LED luminaires

Dimmable LED luminaires

KE dimmable with sensor

Conclusions

- The right light provides optimal conditions for people and cars, which guarantees safety.
- In installations with different heights, KE incorporates the right optics to adapt the light to each area.

Wireless control

- Intelligent luminaires increase energy savings through better use of the light when and where needed.
- Wireless control, sensors and scenes optimize the installation to **save costs with flexibility**.
- Professional and easy commissioning makes **installation efficient**.

Case study

Illuminating a warehouse with NEZA



Case study with different optics

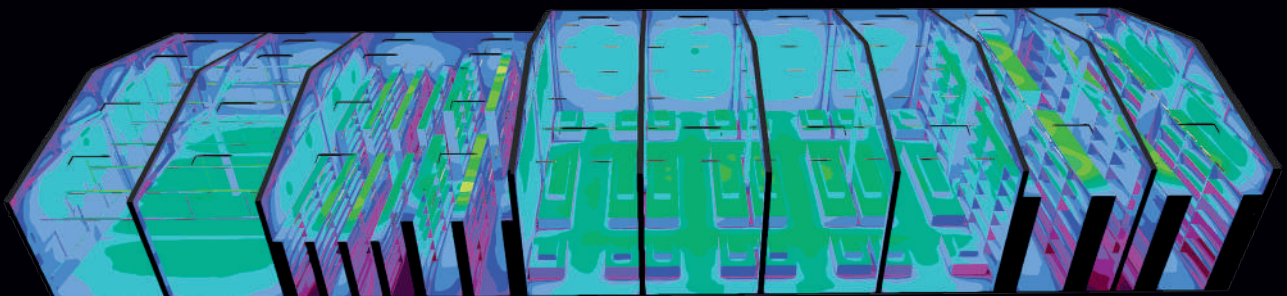
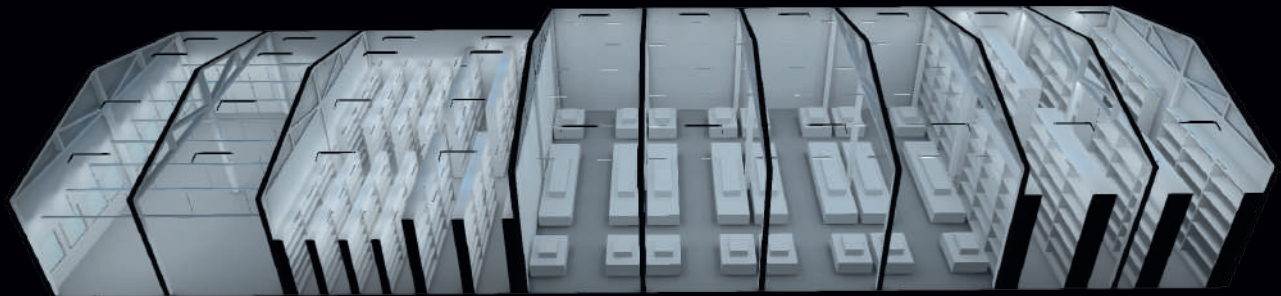
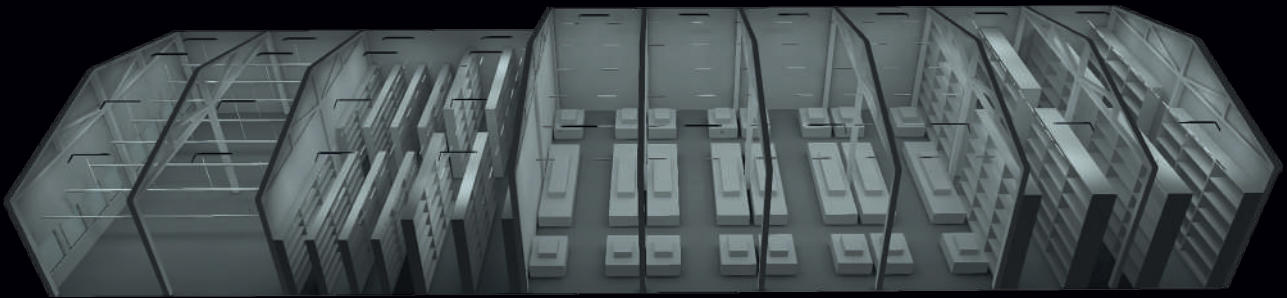

Introduction

- Large and high warehouses require efficient lighting solutions that contribute to **workers safety and productivity**.
- Warehouses must ensure safety and **optimal visual conditions** for workers and forklifts at the right time.
- It is possible to illuminate a warehouse with **different storage areas and mounting heights** with a single luminaire.

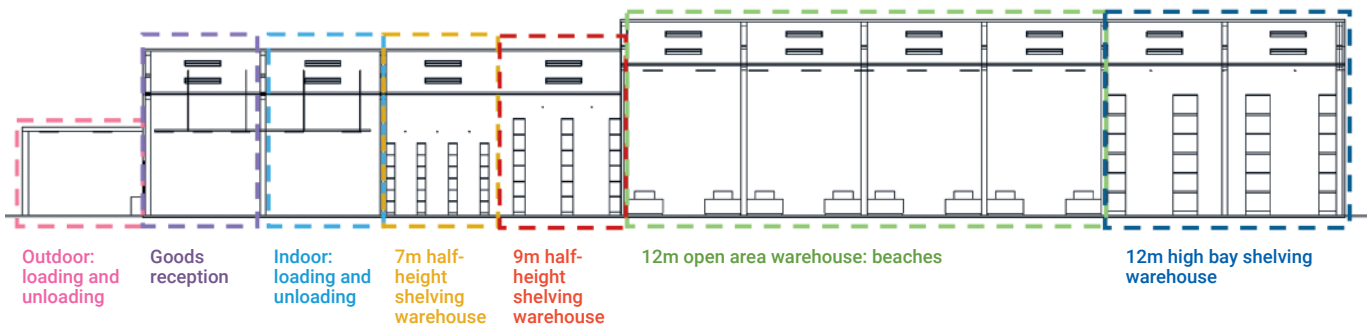
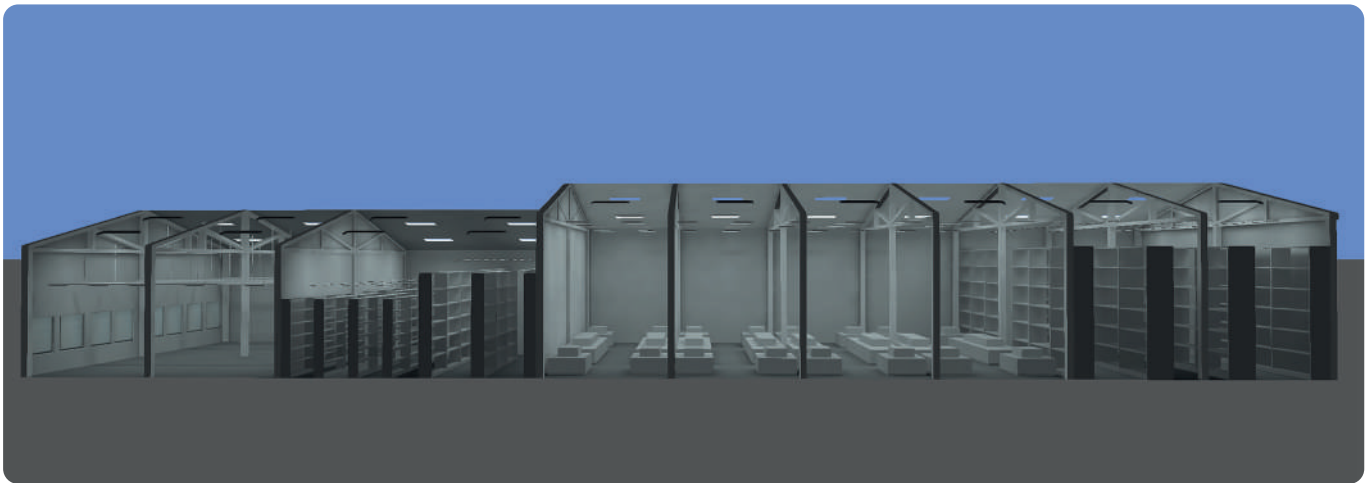

Challenges

1. **Big and high spaces:** workers and forklifts need a clear sight of the goods and their surroundings to drive quick and safely.
2. **Location of the goods:** optimal visual conditions are required on the floor and in the upper regions of the shelves.
3. **Dust:** transport of goods brings dust, which fly around when forklifts drive by.
4. **Visual comfort:** light must be enough and comfortable for workers to move securely and be concentrated, without glare.
5. **Maintenance:** warehouses usually have very high ceilings, so luminaires are installed out of reach.
6. **Different use:** some areas are used during short times, while others 24/7, so dimming can adapt the light to the needs

NEZA

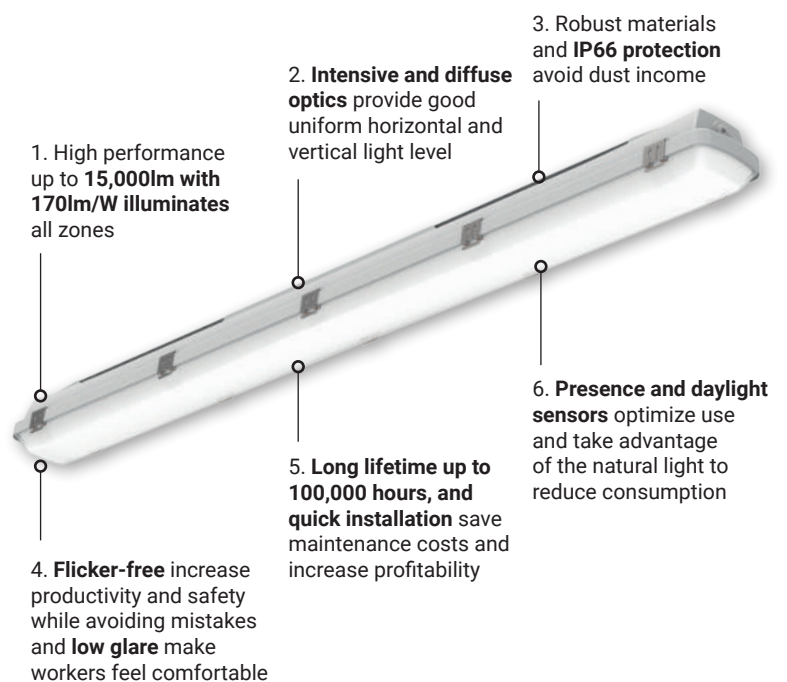

Application of NEZA optics

In 12m and 9m areas, we have installed NEZA luminaires with 10,000lm and intensive optics.

In shelving warehouse (7m), there are NEZA luminaires with 8,000lm and intensive optics, while in the rest of the areas we have installed a diffuse optics version.

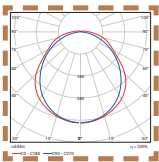
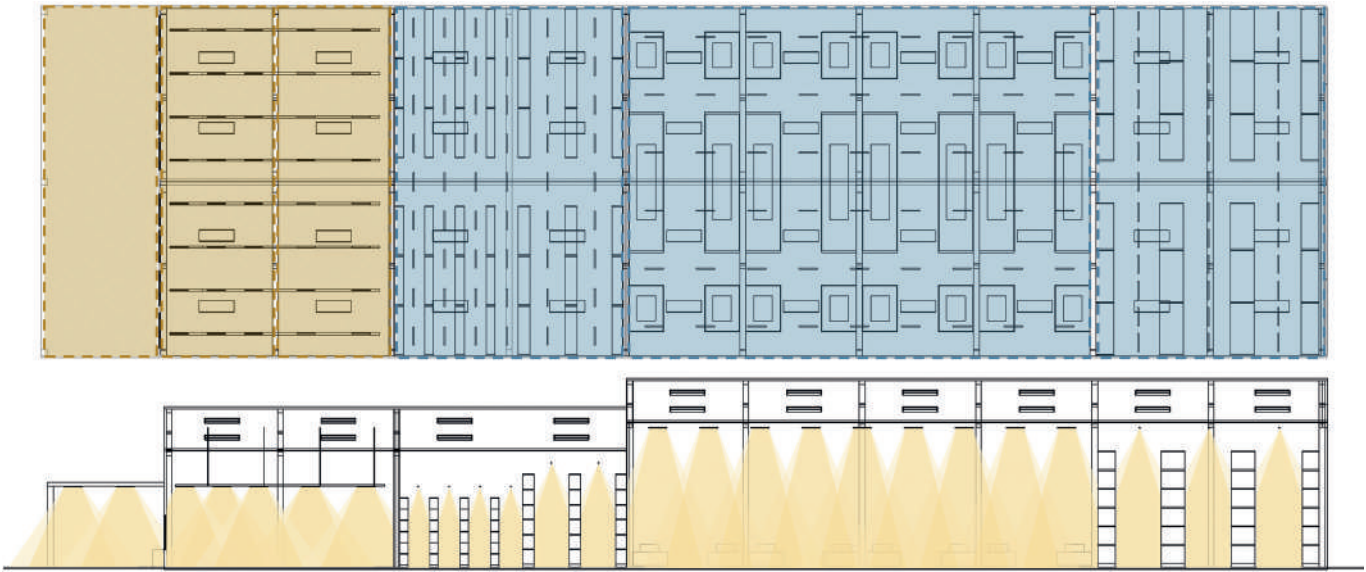

Diffuse

Low and half-height open areas.
Mounting height 7m.

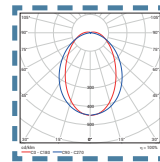

Narrow

Half-height corridors, high bay open areas
and high bay corridors.
Mounting height between 7 and 12m.

• Good uniform light both vertical and on the floor

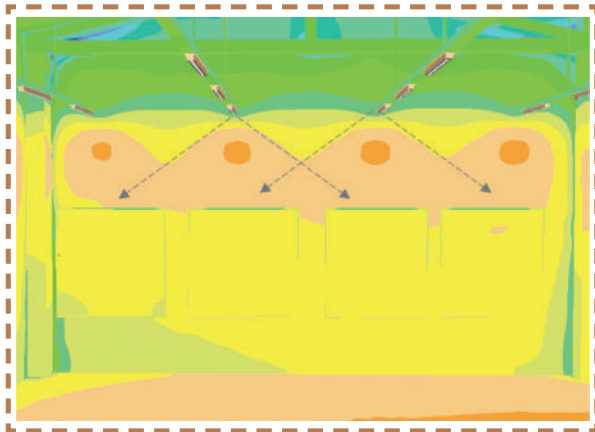

Side view goods reception 7m
Emed. Floor 320 lux
Uniformity 0.77

• Good light level and visual comfort for the highest areas



Side view high bay corridor with shelving 12m
Emed. Floor 156 lux
Uniformity 0.62

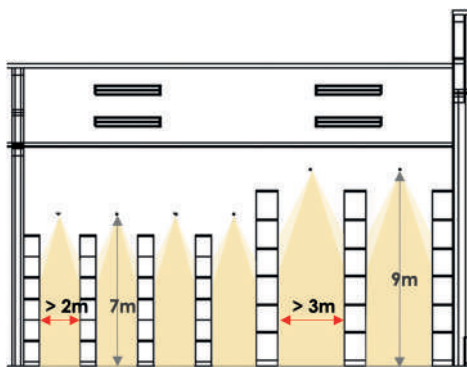

7m half-height shelving warehouse

9m half-height shelving warehouse

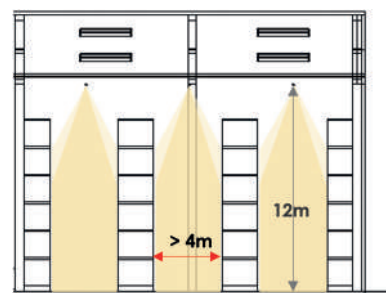

12m half-height shelving warehouse

Achievement of lighting requirements

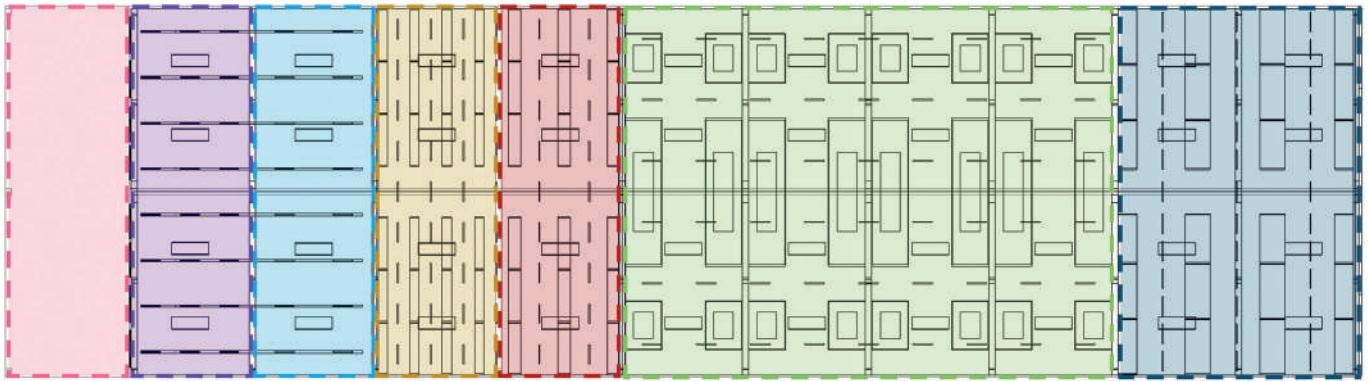

**Outdoor:
Loading and
unloading**

E_{med} : 100lux
 U_o : 0.4

**Goods
reception**

E_{med} : 300lux
 U_o : 0.5

**Indoor:
loading and
unloading**

E_{med} : 200lux
 U_o : 0.5

**7m half-high
shelving
warehouse**

E_{med} : 150lux
 U_o : 0.4

**9m half-height
shelving
warehouse**

E_{med} : 150lux
 U_o : 0.4

**12m open area
warehouse:
beaches**

E_{med} : 150lux
 U_o : 0.4

**12m high bay
shelving
warehouse**

E_{med} : 150lux
 U_o : 0.4

Applicable standards for lighting levels: UNE EN -12464-1 for indoor areas and UNE EN -12464-2 for outdoor areas.

Energy savings

Compared to traditional luminaires, dimmable LED luminaires in combination with daylight sensors can achieve up to 70% energy savings and reduce CO2 emissions by 49 tons per year.

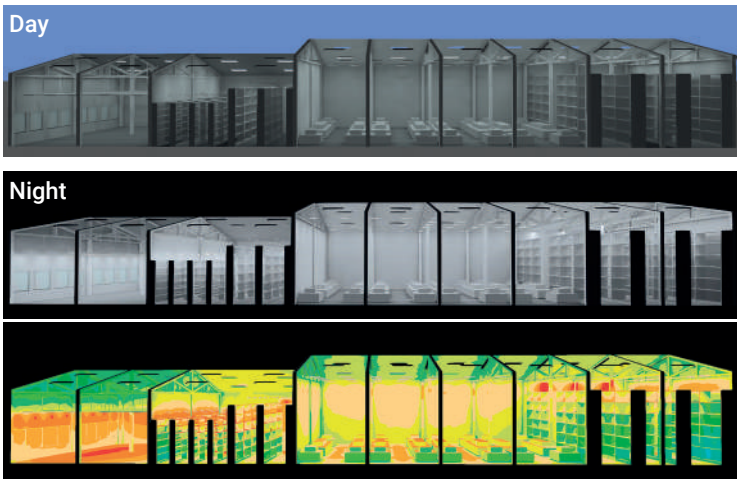

Evolution of daylight vs. artificial light input

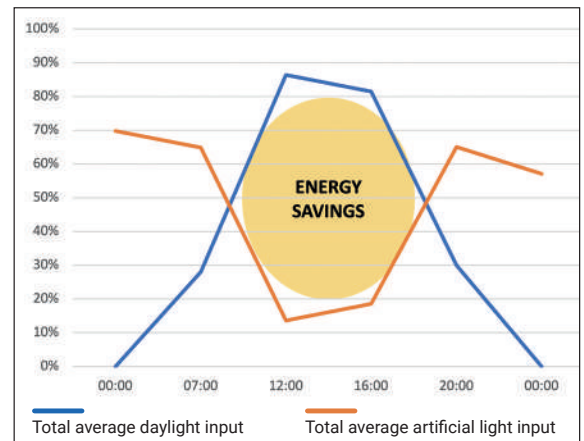

Electrical figures	
Luminaires power consumption, per year	46,836 kW
Electricity cost	0.24 €/kWh
Working hours, per year	7,920 h
ROI	~1.5 years

Based on the average cost of electricity in Spain

Total cost of energy per year (€)

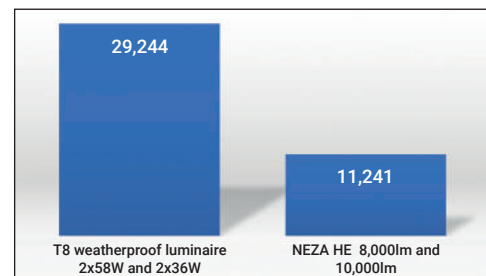

Conclusions

- The right light provides **optimal visual conditions**, which increases safety and concentration of workers in warehouses.
- In areas with corridors, both **horizontal and vertical illuminance is important**, so choosing the right light distribution implies a better recognition of boxes and materials in all shelving.
- Thanks to the incorporation of wireless control and daylight sensor, the installation can **take advantage of the natural light to reduce the energy consumption** while providing a good light level inside the warehouse.
- Even in high heights around 12m, typical in mechanized logistics areas, lighting can be optimized with **presence sensors which only turn lights on when needed**.

Technical Information

Specifications

- Luminaires are specified for indoor use and under shelter for outdoor use, unless otherwise noted.
- Net luminaire data at 25°C ambient temperature, unless otherwise specified.
- Outside the recommended ambient temperature range, luminaire lifetime will be reduced.
- Data tolerance must be considered between +/- 5 %.
- Our luminaires comply with the EU Declaration of Conformity and are Made in Europe.
- General guarantee terms apply: see the updated document in our website.
- All information is subject to change without notice due to development. Please, refer to www.zalux.com for current versions of product documentation.



Indoor



Outdoor



Outdoor under
shelter



Suspended



Ceiling
mounting



Wall
mounting



Operational temperature range under which the luminaire have to be installed. Out of this interval, its electronic components could be affected as well as the lifetime of the luminaire.

Made in EU



Luminaires with emergency kit

- ZALUX luminaires can be equipped with emergency kit.
- Kit transforms a LED luminaire into an emergency luminaire when necessary.
- It includes a long lasting LiFePO4 battery and an emergency converter.
- Unless otherwise specified, emergency kits are non-permanent, thus, they only work in case of mains failure. The rest of the time the battery is being charged or is at rest.

Icons



The product complies with the dispositions of the European Community. Luminaires must comply with 2004/108/EC for Electromagnetic Compatibility, 2006/95/EC for the production of the luminaires and 2009/125/EC for ecodesign.



Marking common to luminaires, associated equipments and information technology equipments, that indicates the conformity with European standards. The complying of the norms by the manufacturers is tested by external official bodies (AENOR, VDE...).



Compatibility for safety approval certification is confirmed by the Certification Body (CB) of each standard based on the test result provided by the authorized test laboratory.



Luminaires comply with the specifications of foodstuff legislation in accordance with Regulation (EU) No. 852/2004 (HACCP) Appendix II Section I No. 2 a, b Section II No. 1c for luminaires, and can be used in applications where foodstuffs are processed, handled and packed.

RoHS

The RoHS Directive restricts the use of six hazardous materials in the manufacture of electronic and electrical equipment: lead, mercury, cadmium, hexavalent chromium, polybrominated biphenyls (PBB) and polybrominated diphenyl ethers (PBDE).

REACH

Luminaires comply with the related requirements of European Union Regulation (EC) 1907/2006 concerning the Registration, Evaluation, Authorization and Restriction of Chemicals (REACH).



Class I luminaires are earthed.

PWIS-free

Luminaires are 100% free of paint-wetting impairment substances.



Luminaires with limited external surface temperatures. They can be used in places where it is needed to limit external surface temperatures, due to the risk of accumulating combustible dust on the luminaires, but without an atmosphere with risk of an explosion.

Applications



Automotive



Aviation



Car wash



Cellar



Chemical



Cloakroom



Corridor



Factory



Farm



Food



High bay



High moisture



Kitchen



Laboratory



Logistics



Maritime



Parking



Pharma



S pool



Sheds



Smart parking



Storage



Transport



Tyres storage



Warehouse



Workshop

Resistance to chemical agents

Chemical agents	Polyester	Polycarbonate	Aluminium	PMMA	Stainless steel
Acetic acid 10%	✓	✓	✓	✓	✓
Acetone	∅	X	✓	X	✓
Alcoholic beverages	✓	✓	✓	∅	✓
Aluminium sulphate	✓	✓	✓	✓	∅
Ammonia 5%	∅	X	✓	✓	✓
Aniline	∅	X	✓	X	✓
Arsenic acid 20%	∅	✓	✓	✓	✓
Benzene	X	X	✓	X	∅
Bencylic alcohol	X	X	∅	X	∅
Bromine	X	X	X	X	X
Calcium Chloride	✓	✓	✓	✓	∅
Calcium nitrate	✓	✓	✓	✓	∅
Carbon tetrachloride	X	X	✓	X	∅
Carbonic acid	✓	X	✓	X	✓
Caustic potash 5%	X	X	X	✓	∅
Cement	✓	✓	✓	✓	∅
Hydrochloric acid 1-5%	∅	✓	X	✓	X
Chlorine liquids (vapours)	X	X	X	X	∅
Chloroform	X	X	✓	X	✓
Chromic acid	X	∅	X	∅	∅
Citric acid 20%	✓	✓	✓	✓	∅
Copper sulphate	✓	✓	X	✓	∅
Diesel-naphta oil	✓	∅	✓	✓	✓
Ethyl alcohol 30%	✓	✓	✓	∅	✓
Ethyl chloride	X	X	∅	X	✓
Ethyl ether	✓	X	✓	X	∅
Food oils and fats	✓	X	✓	✓	✓
Formic acid 10%	∅	✓	X	✓	∅
Glycerine	✓	✓	✓	✓	✓
Hexane	∅	✓	✓	✓	✓
Iodine	✓	X	∅	✓	X
Isopropylic alcohol	✓	∅	✓	∅	∅
Lubricating oil	✓	✓	✓	✓	✓
Magnesium sulphate	✓	✓	✓	✓	✓
Methanol	✓	X	✓	∅	✓
Mineral oils	✓	✓	✓	✓	✓
Nitric acid 20%	X	∅	X	✓	✓
Oxygen	✓	✓	✓	✓	✓
Ozone	✓	✓	✓	✓	∅
Perchloric acid 10%	X	✓	X	✓	X
Petrol	✓	X	✓	✓	✓
Phenol	∅	X	✓	X	∅
Potassium bromide	✓	✓	∅	✓	∅
Potassium nitrate	✓	✓	✓	✓	∅
Potassium permanganate	✓	✓	✓	✓	∅
Sea climate	✓	✓	∅	✓	∅
Silicon oils	✓	✓	✓	∅	✓
Soda bleach 15%	✓	X	∅	✓	∅
Sodium chloride	✓	✓	∅	✓	∅
Sodium hydroxide 5%	✓	X	X	✓	∅
Sodium sulphate	✓	✓	✓	✓	∅
Sugar	✓	✓	✓	✓	✓
Sulphur	✓	✓	✓	✓	∅
Sulphuric acid 30%	X	✓	X	✓	X
Toluene	X	X	✓	X	✓
Trichloroethylene	X	X	✓	X	∅
Zinc sulphate	✓	✓	∅	✓	∅

- ✓ Resistant
- ∅ Relatively resistant
- X Non-resistant

This is a recommendation about the compatibility of equivalent or similar chemical agents included in the composition of the cleaning products with the polymers present in the luminaires. It is based on information from material suppliers, available documentation, tests and our experience in different Applications.

Materials resistance can be also affected by concentration, temperature, presence of various chemicals, solvent evaporation and other factors, so this table must be considered as a general reference. Product compliance must be determined by the customer for each specific use.

Ingress protection: IP

The protection of luminaires against the penetration of dust, solid matter and dampness is in accordance with UNE-EN 605929 and UNE-EN 60598-1 standards.



IP66

Protection against the penetration of solid matter and dust.

0	Unprotected
1	Protected against solid matter greater than 50 mm
2	Protected against solid matter greater than 12 mm
3	Protected against solid matter greater than 2.5 mm
4	Protected against solid matter greater than 1 mm (e.g. small tools, small cables, etc.)
5	Protected against dust (without damaging sediment)
6	Protected against dust



IP66

Protection against the penetration of liquids.

0	Unprotected
1	Protected against vertical water splashes (condensation)
2	Protected against water splashes of up to 15° of the vertical
3	Protected against water splashes of up to 60° of the vertical
4	Protected against water projections in all directions
5	Protected against water assault in all directions
6	Protected against water assault similar to heavy seas
7	Protected against immersion
8	Protected against prolonged effects of underwater immersion
9(80°C)	Protected against high-pressure and temperature water jet.

Impact protection: IK



IK08

00	Unprotected
01	Impact Energy 0.15 Joules
02	Impact Energy 0.20 Joules
03	Impact Energy 0.35 Joules
04	Impact Energy 0.50 Joules
05	Impact Energy 0.70 Joules
06	Impact Energy 1 Joule
07	Impact Energy 2 Joules
08	Impact Energy 5 Joules
09	Impact Energy 10 Joules
10	Impact Energy 20 Joules

General sale conditions

Our acceptance of an order entails, in any event, that the buyer accepts the following general conditions of sale and supply:

1. Source of supply

ZALUX luminaires can be obtained through our established network of distributors in the different countries.

2. Offers

The written, oral and telephone offers are without compromise. The delivery of offers does not oblige us to accept the order. All orders and compromises are only valid if we have expressly ratified them in writing.

3. Prices

The prices of the Price List in force are understood to be for materials in stock. We reserve the right to modify the prices; if it is possible, said variation will be communicated in the best possible time.

4. Delivery time

Delivery time will be confirmed individually once the order is accepted. Delivery time set by ZALUX, S.A., will be respected and only modified due to production or force majeure. Delay will be communicated to the customer in advance, for his approval. Delivery delays will not allow the buyer to neither cancel the order nor to apply any penalty nor indemnifications for it, except for the case that it has been specifically agreed in advance.

5. Orders

ZALUX, S.A., can unilaterally annul current orders, if the circumstances of a main force that impede their completion should occur. Understood as circumstances of a main force: industrial disputes, labour disruptions, shortage of raw materials, etc. The buyer cannot annul orders for specially made materials without our written agreement. In case of acceptance on our part the expenses incurred up to the moment of cancellation will be charged to the buyer.

6. Packaging

The products are sold in their original cardboard package. Under certain circumstances or the buyer indicates to us to use another package, it will be charged to the buyer at its cost price.

7. Transport

With the delivery of the merchandise to the transport agency the delivery is considered to have been correctly made. The risks of transport of the consignment of our products are on the buyers' account. They can only reclaim from the transport agency for the damages incurred during transport. We will with the utmost pleasure collaborate and support their reclamation with details, etc.

8. Measurements

The measurements are given in millimetres in the descriptions of the models. We reserve the right to introduce small deviations in the measurements as well as modifications due to improvements to the models. The price would be susceptible to variation in this case.

9. Reclamations

ZALUX acknowledges any warranty claim. The acceptance decision is based on the analysis of the cause of the faulty devices. The warranty covers material, design and/or manufacturing defects and applies to the entire product.

Defects caused by insufficient maintenance and/or normal wear and tear according to the nominal service life stated in the technical documentation of the product are excluded from the warranty.

Reclamations regarding numerous faults and defects will only be valid if the proper reclamation if the corresponding complaint is submitted within seven days as from the reception of the goods. If the reclamation is founded and the goods are in its original state, a corresponding acceptance will be sent.

For more information about our warranty conditions, please visit www.zalux.com/downloads/

10. Return of material

Return of material will not be accepted for reasons of mistaken instructions, shapes, quantities or material to be repaired, if we have not previously given our written authorisation. Those returns must be sent DDP ZALUX and 30% demerit of the original value will be applied. We do not accept the return of specially made products.

For more information about our return policy, please visit www.zalux.com/downloads/

11. Property rights

In all cases and even against a third party, ZALUX, S.A., conserves full ownership of all the supplied materials, in the case that the agreed payment has not been settled.

12. Patent rights

All the models in this catalogue are protected by law. Legal action with right to redemption will be taken against anyone making imitations.

13. Reprints

Total or partial reproduction of this catalogue is forbidden without the corresponding written authorisation of ZALUX, S.A.

14. Payment

The form of payment will be established at the time of making a firm order for the merchandise, in accordance with the usual standards in ZALUX, S.A.

15. Jurisdiction

For any question that could arise in the completion or interpretation of these general rules, the contracting parties, with expressly renouncing any local law code that could correspond to them, will be submitted expressly to the Magistrate Law Courts of Zaragoza.

16. Modifications

ZALUX, S.A. in its continuous improvement process, reserves the right to modify its technical specifications without any previous notice.

The buyer is responsible that the product purchased in components, once fully wired, meets the requirements of the respective country.

The partner you can trust



The partner you can trust

Avda. Manuel Rodríguez Ayuso, 114
Centro Empresarial Miralbueno

Planta 1ª – Local P2.
E-50012 Zaragoza, Spain

Tel.: +34 976 462 200
info@zalux.com

zalux.com

